

# Purine Bases, Nucleosides, and Nucleotides: Aqueous Solution Redox Chemistry and Transformation Reactions of Their Radical Cations and $e^-$ and OH Adducts

STEEN STEENKEN

Max-Planck-Institut für Strahlenchemie, D-4330 Mülheim, Federal Republic of Germany

Received July 18, 1988 (Revised Manuscript Received November 17, 1988)

## Contents

|  |     |
|--|-----|
| I. Introduction: The Redox Titration Technique                                   | 503 |
| II. One-Electron Reduction of Purines  | 504 |
| A. Reactivity with $e_{aq}^-$  | 504 |
| B. Protonation Reactions of the $e^-$ Adducts:<br>N-Protonation vs C-Protonation | 504 |
| III. One-Electron Oxidation of Purines   | 507 |
| A. The Adenine System  | 507 |
| B. The Guanine System  | 509 |
| IV. Reactions of the OH Radical  | 510 |
| A. The Guanine System  | 511 |
| B. The Adenine System  | 513 |
| V. Implications regarding DNA  | 515 |
| VI. References and Notes   | 518 |



Steen Steenken was born in Wildeshausen, Germany. He received his B.A. degree from Dartmouth College, Hanover, NH, as a Fulbright Scholar in 1960. After returning to Germany, he studied at the University of Munich, where he received his Ph.D. degree in physical chemistry (heterogeneous catalysis) in 1966. After postdoctoral work in radiation biology in Munich, he joined the Max-Planck-Institut für Strahlenchemie in 1971. In 1977/1978 he spent a sabbatical at the Radiation Laboratory at Notre Dame, IN. His present research interests include electron spin resonance of short-lived radicals, selectivity in radical-molecule reactions, mechanisms of redox reactions between radicals and molecules, and, lately, photoheterolytic reactions.

## I. Introduction: The Redox Titration Technique

Ever since the early days of radiation chemistry and biology it has been realized that the purine and pyrimidine bases are the most sensitive to radiation-induced modification or destruction of the components of DNA, itself the most critical of the cellular targets.<sup>1</sup> Attempts to understand the radical chemistry leading from the primary ionization event to the final nonradical products have involved the use of three general "tools": (a) product analysis studies on, mainly, the building blocks of DNA and model compounds for them,<sup>1,2</sup> (b) electron spin resonance (ESR) in matrices, single crystals, and liquid solution,<sup>3</sup> and (c) time-resolved methods (pulse radiolysis), with predominantly optical and conductance detection,<sup>4</sup> again mainly on the constituents of DNA and their model compounds. As a result of these pulse radiolysis studies there has become available a large and coherent body of information on the reactivity of DNA and its components not only with the primary radical species from the radiolysis of water,  $e_{aq}^{\bullet-}$ ,  $H^{\bullet}$ , and  $\bullet OH$  (abbreviated as  $e_{aq}^-$ ,  $H$ , and  $OH$ ) but also with many "secondary" radicals produced from organic or inorganic molecules by reaction with the former.<sup>4,5</sup> A result of major importance is that, of the DNA constituents, the pyrimidines and the purines have a very high reactivity with respect to both  $e_{aq}^-$  and  $OH$  (rate constants  $10^9$ – $10^{10} M^{-1} s^{-1}$ ), whereas the ribose phosphate moiety is less reactive with  $OH$  (typically, rate constants  $10^9 M^{-1} s^{-1}$ ) and almost unreactive with respect to  $e_{aq}^-$  (rate constants  $<10^7 M^{-1} s^{-1}$ ). An  $e_{aq}^-$  produced near a DNA chain will therefore end up with a pyrimidine or purine base, whereas an  $OH$  radical is as well likely to be scavenged by a deoxyribose unit, a reaction that has a good chance of leading to a DNA chain break.<sup>6</sup>

It has been the aim of investigators not only to learn about the *reactivity* of the nucleic acid bases but also to *identify their reaction products* with  $e_{aq}^-$ ,  $H$ , and  $OH$ . In the case of the pyrimidines there has recently been considerable progress to achieve this goal, mainly due to the refinement of the "redox titration" technique,<sup>7</sup> which consists in titrating a mixture of (isomeric) radicals by taking advantage of even slight differences in their ease of oxidation or reduction by stable oxidants or reductants. Quite generally, the oxidation state of radicals can be changed easily since radicals are in between two stable oxidation states. Particularly as a result of finding suitable reductants for the oxidizing pyrimidine radicals (identified as the pyrimidin-5-yl radicals),<sup>8,9</sup> it was possible to establish a mass balance that accounts quantitatively for the reaction of the  $OH$  radical with the naturally occurring pyrimidines<sup>8-10</sup> and with a series of 5,6-dihydrouracils.<sup>11</sup> The results<sup>8-11</sup> support and expand earlier data<sup>12</sup> obtained by titrating only the reducing radicals.

The redox titration technique has also been applied to the reaction of the oxidizing  $SO_4^{\bullet-}$  with pyrimidine and purine nucleotides,<sup>13</sup> to reactions of the  $H$  atom,<sup>14</sup> and even to  $e_{aq}^-$  reactions.<sup>15</sup> Concerning the latter, it has been possible to demonstrate the protonation in aqueous solution on *carbon* of the electron adducts,<sup>15,16</sup>

TABLE I. Rate Constants for Reaction of  $e_{aq}^-$  with Purine(s) and Its Constituents

| substrate              | $k(e_{aq}^-)/(M^{-1} s^{-1})$  | pH   | ref |
|------------------------|--------------------------------|------|-----|
| imidazole              | $2.2 \times 10^7$              | 11   | 119 |
| pyrimidine             | $2.0 \times 10^{10}$           | 7    | 39  |
| purine                 | $2.1 \times 10^{10}$           | 6    | 20  |
| purine anion           | $6.5 \times 10^9$              | 11   | 20  |
| adenine                | $9.0 \times 10^9$              | 7    | 120 |
| adenine anion          | $1.1 \times 10^9$              | 11   | 120 |
| adenosine              | $1.1 \times 10^{10}$           | 6-11 | 119 |
| 2'-deoxyadenosine      | $8.2 \times 10^9$              | 7    | 22  |
| adenosine 5'-phosphate | $3.8 \times 10^9$              | 6-12 | 119 |
| guanine                | $1.4 \times 10^{10}$           | 7    | 119 |
| guanine anion          | $2.0 \times 10^9$              | 11   | 119 |
| guanosine              | $6.0 \times 10^9$              | 6.7  | 20  |
| hypoxanthine           | $1.7 \times 10^{10}$           | 6.6  | 119 |
| poly(A)                | $2.5 \times 10^8$ <sup>a</sup> | 7    | 120 |
| poly(A+U)              | $1.3 \times 10^8$ <sup>a</sup> | 7    | 120 |
| DNA                    | $1.4 \times 10^8$ <sup>a</sup> | 7    | 120 |
| ribose                 | $<10^7$                        |      | 119 |

<sup>a</sup>Rate constant per nucleotide unit.

a reaction that in the case of thymine gives the famous 5,6-dihydro-5-yl radical, long known by ESR spectroscopists to be formed by radiation in matrices, single crystals, and DNA.<sup>17</sup> By protonation on carbon the reducing electron adduct is converted into the oxidizing<sup>8</sup> 5-yl radical, an example of "redox inversion",<sup>18,19</sup> and it is this change in the redox polarity that makes the reaction recognizable by redox titration. However, it has to be kept in mind that, in contrast to ESR,<sup>16</sup> redox titration is an *indirect* method whose applicability in practice depends on the fulfillment of conditions such as (a) selectivity (obtained by perfect matching of oxidizing and reducing power of the partners undergoing the redox reaction), (b) absence of side reactions (such as addition),<sup>18,19</sup> and (c) assignability of radicals as reductants or oxidants. It is in this latter respect that the purine-derived-radicals present particular problems, and this is in part why progress in elucidating their identity and their reactions has been considerably slower than in the case of the pyrimidines. To overcome the problems in understanding the radical chemistry of the purines, all of the aforementioned "tools" have to be applied, and in the following an attempt will be made to integrate into the pulse radiolysis picture relevant information from product analysis and electron spin resonance, the literature covered extending into the first half of 1988.

## II. One-Electron Reduction of Purines

### A. Reactivity with $e_{aq}^-$

The purines (1) have a very high intrinsic reactivity with  $e_{aq}^-$ . This property is endowed by the electron-

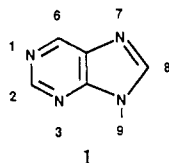

deficient pyrimidine, as seen from the data in Table I. All purines react as neutral bases with  $e_{aq}^-$  with second-order rate constants  $k(e_{aq}^-) \approx 10^{10} M^{-1} s^{-1}$ , essentially independent of their individual structure. The same high reactivity is observed for the purine nucleosides. However, on introduction of one phosphate

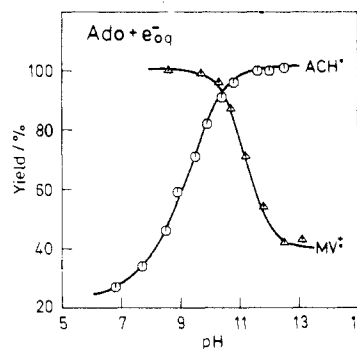

Figure 1. Dependence on pH of (a) the reducing equivalents as titrated by  $MV^{2+}$  ( $\Delta$ ) and (b) the yield of carbon-protonated electron adduct of adenosine (O). With (a), [adenosine] = 2.5 mM, 1 M *tert*-butyl alcohol,  $[MV^{2+}] = 0.1$  mM; with (b), [adenosine] = 2 mM, [*tert*-butyl alcohol] = 0.5 M.

group into the system the rate constants decrease. Since phosphate groups are not expected to reduce the electron affinity of the base moieties, this rate-decreasing effect must be due to electrostatic repulsion between the negatively charged reactants,  $e_{aq}^-$  and nucleotide. Repulsion is, of course, multiplied in the case of the polynucleotides, such as poly(A) or DNA, where the second-order rate constants are as low as  $10^8 M^{-1} s^{-1}$  per nucleotide unit.

Rate constants for reaction with  $e_{aq}^-$  also decrease on ionization of the bases, as with purine ( $pK_a = 8.9$ ), adenine ( $pK_a = 9.8$ ), or guanine ( $pK_a = 9.6$ ) (see Table I). Here the effect is larger than that on going from nucleoside to nucleotide, and this is obviously the result of the electrostatic effect (due to anion formation) and the resulting *decrease* in the electron deficiency of the heterocyclic system working in the same direction.

### B. Protonation Reactions of the $e^-$ Adducts: N-Protonation vs C-Protonation

In the past there have been only few attempts aimed at elucidating in detail the chemical nature and the further reactions of purine electron adducts. Notable among these are the investigations of Moorthy and Hayon,<sup>20</sup> Sevilla et al.,<sup>21</sup> and Hissung et al.<sup>22</sup> The compounds studied by Moorthy and Hayon are purine, 9-methylpurine, adenosine, guanosine, and 1-methylguanosine. The authors found that in all cases the absorption spectra of the electron adducts change with pH in a way that was interpreted in terms of protonation equilibria of the  $e_{aq}^-$  adducts. In the case of adenosine they came to the conclusion that the radical existing in the pH range 5-9 (characterized by  $\lambda_{max} = 320$  nm and  $\epsilon(320 \text{ nm}) = 4.9 \times 10^3 M^{-1} \text{ cm}^{-1}$ ) is a doubly protonated electron adduct, i.e., a radical with a single positive charge (a radical cation). However, by performing conductance experiments (on 2'-deoxyadenosine), Hissung et al. were able to demonstrate<sup>22</sup> that the electron adduct is *monoprotonated* (i.e., it is a neutral radical) and that this is the case not only at pH 4-9 but also up to pH 11.5, where Moorthy and Hayon had observed the formation of a different form of the electron adduct which they assigned to the *monoprotonated* species. The existence of this high-pH form of the radical was confirmed by Hissung et al. Since this radical is also neutral, like the one at neutral pH, it was clear<sup>22</sup> that the transformation of the neutral-pH species into the high-pH one with an "inflection

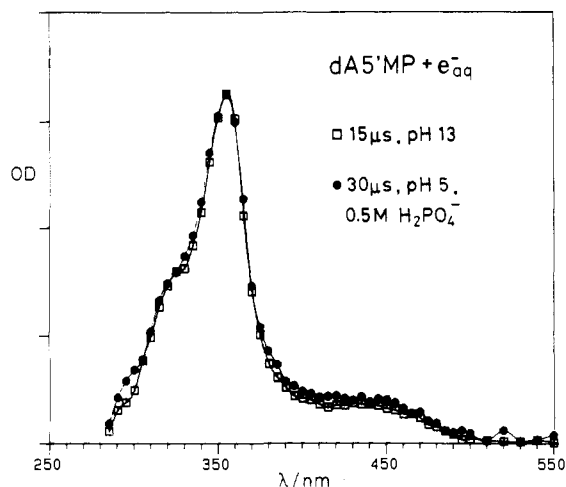

**Figure 2.** Absorption spectra observed on reaction of  $e_{aq}^-$  with 0.4 mM 2'-deoxyadenosine 5'-phosphate, [*tert*-butyl alcohol] = 0.5 M: (□) at pH 13, spectrum measured at 15  $\mu$ s after the pulse; (●) at pH 5 in the presence of 0.5 M phosphate, spectrum measured 30  $\mu$ s after the pulse. The spectra have been normalized to give the same amplitude at  $\lambda_{max}$ .

point" at pH 10.5<sup>20,22</sup> (see Figure 1) is *not* a deprotonation equilibrium but involves a "rearrangement" reaction.

This conclusion<sup>22</sup> has recently been confirmed by Visscher et al.<sup>23</sup> Using conductance and optical detection with nanosecond time resolution, they demonstrated that the electron adduct of adenosine (subsequently denoted by  $A^{\cdot-}$ ) is protonated by  $H_2O$  in <5 ns ( $k(\text{protonation}) \geq 1.4 \times 10^8 \text{ s}^{-1}$ ). The product thus formed (named  $ANH^{\cdot}$  in the following; see Scheme I) is a strongly reducing radical. It is able to transfer an electron to the oxidants *p*-nitroacetophenone (pNAP) with the rate constant  $5 \times 10^9 \text{ M}^{-1} \text{ s}^{-1}$ <sup>22</sup> and methylviologen ( $MV^{2+}$ ) with  $k = 2.5 \times 10^9 \text{ M}^{-1} \text{ s}^{-1}$  at pH 7.<sup>24</sup> The oxidation of  $ANH^{\cdot}$  by pNAP, which was reported *not* to result in regeneration (repair) of the nucleoside,<sup>22</sup> leads to almost quantitative (84%)<sup>25</sup> reduction of pNAP at pH 5.5–9.

When  $MV^{2+}$  is used as a one-electron oxidant with a low tendency to undergo addition reactions,<sup>27</sup> the electron transfer from  $ANH^{\cdot}$  (which leads to the radical cation  $MV^{\cdot+}$  with a  $\lambda_{max}$  at 605 nm and  $\epsilon = 12\,800 \text{ M}^{-1} \text{ cm}^{-1}$ ) is quantitative between pH 5 and 9.<sup>24</sup> However, the situation is drastically changed if the pH is raised above 10. This is shown in Figure 1, which contains the dependence on pH of the reducing equivalents (titrated by  $MV^{2+}$ ) in a solution of adenosine reacted with  $e_{aq}^-$ . The dependence is similar to that previously observed<sup>22</sup> with pNAP as a titrant. Also shown is the dependence on pH of the optical density at 355 nm, the  $\lambda_{max}$  of the "rearranged" species.<sup>20–23</sup> It is obvious that the  $OH^-$ -induced formation of this species is accompanied by a loss in reducing power. The yield of  $MV^{\cdot+}$  measured at pH 13 corresponds to a quantitative loss of reducing equivalents if corrected for the direct reaction between  $MV^{2+}$  and  $ANH^{\cdot}/A^{\cdot-}$ .<sup>24</sup>

It has now been found that the "rearranged" species ( $\lambda_{max} = 355 \text{ nm}$ ), assigned to the radical(s)  $ACH^{\cdot}$  (see Scheme I), can also be produced around neutral pH by catalysis using the phosphate mono- or dianion.<sup>24</sup> This is demonstrated in Figure 2 in which (using adenosine 5'-phosphate as an example) the absorption spectrum measured at pH 13 is compared with that obtained at

pH 5 in the presence of 0.5 M phosphate. The spectra are obviously very similar, showing that the same radical(s) is (are) produced under the two conditions. Phosphate catalyzes the conversion of  $ANH^{\cdot}$  into  $ACH^{\cdot}$  also at higher pH values, such as 9, but the highest catalytic rate constant is observed (for the adenosine case) at pH  $\sim 7$  (where the monoanion  $H_2PO_4^-$  and the dianion  $HPO_4^{2-}$  exist in approximately equal amounts). That phosphate catalysis leads to the same radical as that produced by the  $OH^-$ -induced reaction is also evident from the fact<sup>24</sup> that the former radical, like the latter, is not able to reduce  $MV^{2+}$ . Phosphate catalysis of protonations on carbon has previously been seen with electron adducts of fumarate<sup>28</sup> and pyrimidines.<sup>15,16</sup>

From ESR spectroscopy of purine radicals produced in glasses and in single crystals it has long been known that the electron adduct to the adenine moiety (the "pristine anion") gets protonated (even at 4 K)<sup>3c,e</sup> on a nitrogen and that upon warming, this reaction is followed (via paths not well understood) by a "rearrangement" that results in protonation at *carbon* 2 or 8 of the purine system. The data on this well-documented reaction have been summarized.<sup>3c–e</sup> The conversion of the N-protonated radical  $ANH^{\cdot}$  into the C-protonated one  $ACH^{\cdot}$  formally involves a 1,2-shift of a hydrogen from nitrogen to the adjacent carbon,<sup>29</sup> e.g., for the N3-protonated radical detected<sup>3c,30</sup> in single crystals at 4 K:

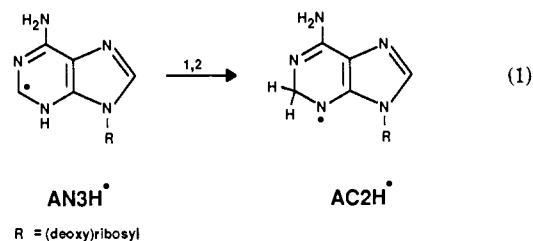

An analogous reaction can be written leading from the adenine electron adduct protonated at N7 to the radical protonated at C8:

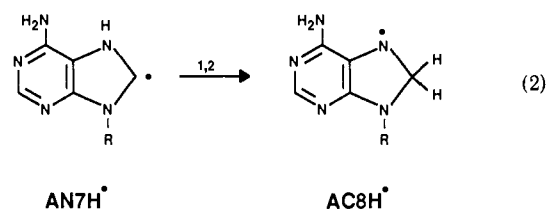

As seen from eq 1 and 2, the N- and the C-protonated radicals differ with respect to the distribution of unpaired spin between the carbon and the nitrogen atoms, the C-protonated species having appreciably more spin density on the electron-affinic nitrogens. On this basis, the C-protonated radical should have a considerably lower tendency to give up an electron; i.e., this radical should be a weaker reductant than the N-protonated one. It should therefore be possible to distinguish between C- and N-protonated radicals by redox titration.

In fact, with this technique<sup>15</sup> and *in situ* radiolysis ESR,<sup>16</sup> it has been possible to demonstrate that the conversion of the electron adducts of uridine and thymidine (and of model compounds) via O4-protonation to the C6-protonated radicals, extremely well documented by ESR in the solid state,<sup>3</sup> takes place also in aqueous solution. This similar response is an important



ACH<sup>•</sup> in (a) neutral, unbuffered solution (pH 6–8) using doses such that  $\leq 1 \mu\text{M}$  radicals were produced (in order to minimize radical–radical reactions) and (b) in solutions containing phosphate as catalyst for the ANH<sup>•</sup> → ACH<sup>•</sup> conversion.<sup>24</sup> The rate of ACH<sup>•</sup> production in these solutions follows the equation  $k(\text{obsd}) = k(\text{NH} \rightarrow \text{CH})_s + k(\text{phosphate})[\text{phosphate}]$ , so the catalytic rate constants  $k(\text{phosphate})$  are obtained from the slope of  $k(\text{obsd})$  vs  $[\text{phosphate}]$  plots and the spontaneous rate,  $k(\text{NH} \rightarrow \text{CH})_s$ , from the intercept. The average rate from method a and b (using solutions at pH 5, 7, and 9) is  $k(\text{NH} \rightarrow \text{CH})_s = (1.4 \pm 0.2) \times 10^4 \text{ s}^{-1}$ .<sup>24</sup> That this rate is a factor  $\sim 200$  less than that for protonation of the anionic radical reflects the lower electron density of the neutral species. Increases of protonation rates on carbon resulting from deprotonation from heteroatoms have previously been observed in the case of electron adducts of acrylate and fumarate<sup>28,34</sup> and of 4,6-dihydropyrimidine.<sup>16</sup>

A rough estimate can be made of the  $\text{p}K_a$  value of ANH<sup>•</sup>. For this purpose it is necessary to make an assumption on either  $k(\text{OH}^-)$  or  $k(\text{NH})$  (see Scheme I for identification of symbols). A reasonable estimate can be made for  $k(\text{OH}^-)$ . Assuming  $k(\text{OH}^-)$  to be  $10^{10} \text{ M}^{-1} \text{ s}^{-1}$ , the experimental  $k(\text{obsd})$  for production of ACH<sup>•</sup> vs  $[\text{OH}^-]$  dependence was simulated by adjusting  $k(\text{NH})$ . The optimized value found for  $k(\text{NH})$  is  $1.4 \times 10^8 \text{ s}^{-1}$ , which, if combined with  $k(\text{OH}^-)$ , gives a  $\text{p}K_a$  value of 12.1 for ANH<sup>•</sup>.<sup>24</sup> It is interesting to compare this value with that (3.5) for deprotonation of the protonated parent compound adenosine, as follows:

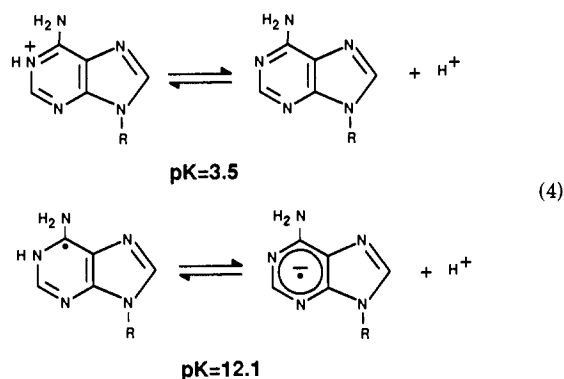

The much higher value for the radical means that by electron addition to adenosine the Brønsted basicity (proton-accepting power) of the molecule is increased by the factor  $4 \times 10^8$ . The consequences for the radiation chemistry of DNA of this drastic change in basicity are discussed in section V. Changes in basicity of similar magnitude resulting from electron addition to heterocyclic compounds are well-known for the simpler systems pyridine,<sup>35–40</sup> pyrimidine, pyrazine, and pyridazine.<sup>39,40</sup> Even larger changes in basicity result from electron addition to nonconjugated systems; compare, e.g., the couple  $(\text{CH}_3)_2\text{COH}^+$  ( $\text{p}K_a < -2$ ) and  $(\text{CH}_3)_2\text{COH}^\bullet$  ( $\text{p}K_a = 12.1$ ).<sup>41</sup>

The ratio of protonation at C2 and C8 (or at other carbon positions?) is as yet unknown. The ESR data<sup>3c–e</sup> contain little quantitative information on this question. It should, however, be in principle possible to distinguish between AC2H<sup>•</sup> and AC8H<sup>•</sup> by redox titration since with AC2H<sup>•</sup> in two of the four valence bond representations of the radical the unpaired spin is on a nitrogen, whereas with AC8H<sup>•</sup> the unpaired spin is on

an electron-affinic nitrogen in only one out of four mesomeric structures. AC8H<sup>•</sup> should therefore be a better reductant than AC2H<sup>•</sup> (see Scheme I).

*Reactions of Purines with H Atoms.* In the solid state, H atoms were found to add at C2 and C8 in adenine and at C8 in guanine derivatives, based on ESR evidence.<sup>3c–e</sup> These reactions yield, of course, the same products as those formed by  $e^-$  addition followed by  $\text{H}^+$  addition at C2 or C8, respectively. Concerning aqueous-phase H-atom reactions, very little information seems to be available. A notable exception is the work of Sevilla et al.,<sup>21</sup> who report that the spectrum of the H adduct of adenosine (measured at pH 13) is different from that observed on  $e_{\text{aq}}^-$  reaction at pH 13 (see Figure 1), which was identified above as ACH<sup>•</sup>. It should be noted, however, that in aqueous solution at pH 2 adenosine is protonated (at N1) and is therefore expected to have a different reactivity with  $\text{H}^\bullet$  than does neutral adenosine.<sup>42</sup>

The  $(\text{CH}_3)_2\text{COH}^\bullet$  radical has also been reacted with purines.<sup>20</sup> With neutral purines, its reactivity is low, i.e.,  $< 10^7 \text{ M}^{-1} \text{ s}^{-1}$ ; however, when the purines are protonated, the reactivity is higher, e.g.,  $k(\text{reaction}) = 5 \times 10^7 \text{ M}^{-1} \text{ s}^{-1}$  for the case of adenosine. The reactions of  $(\text{CH}_3)_2\text{COH}^\bullet$  have been formulated as leading to one-electron reduction of the protonated purines.<sup>20</sup> If this is the case, the reaction is likely to be followed by protonation on carbon, giving rise to an N-protonated carbon-protonated one-electron-reduced adenine system, i.e., a cationic radical.

### III. One-Electron Oxidation of Purines

#### A. The Adenine System

The one-electron oxidation of adenine and its derivatives requires the use of the powerful oxidant  $\text{SO}_4^{\bullet-}$  ( $E^\circ = 2.5\text{--}3.1 \text{ V/NHE}^{43}$ ). Weaker oxidants such as  $\text{Br}_2^{\bullet-}$  ( $E^\circ = 1.6 \text{ V}$ ) or  $\text{Tl}^{2+}$  ( $E^\circ = 2.2 \text{ V}$ ) react<sup>44</sup> with the adenine family with rate constants  $\leq 10^7 \text{ M}^{-1} \text{ s}^{-1}$  and are therefore of little value in pulse radiolysis experiments aimed at producing one-electron-oxidized adenines on the millisecond or shorter time scale. In contrast, the  $\text{SO}_4^{\bullet-}$  radical (produced from peroxydisulfate by  $e_{\text{aq}}^-$  reaction or by photolysis; cf. eq 5) reacts with rates close

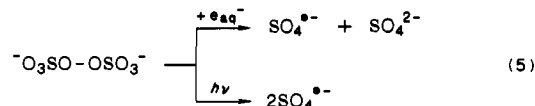

to the diffusional level (see Table II). Inspection of Table II shows that the high rates for reaction of the electrophilic<sup>45</sup>  $\text{SO}_4^{\bullet-}$  with purines are a consequence of the high electron density contributed by the imidazole moiety. The rate increases further on introduction of the electron-donating amino group, i.e., in going from purine to adenine, and it decreases somewhat on reduction of the electron density due to replacement of H at N9 by the electron-withdrawing ribose unit.

In its reaction with adenine nucleosides and nucleotides, the  $\text{SO}_4^{\bullet-}$  radical has a high preference for interaction with the base part of the molecule rather than with the (deoxy)ribose (phosphate) moiety.<sup>13,46</sup> This is in agreement with expectation based on the low rate constant for reaction with ribose 5'-phosphate monoanion (Table II).

**TABLE II. Rate Constants for Reaction of  $\text{SO}_4^{\cdot-}$  with Purine Constituents and Derivatives**

| substrate   | $k(\text{SO}_4^{\cdot-})/(\text{M}^{-1} \text{s}^{-1})$ | notes                     |
|---|---|---------------------------|
| imidazole   | $5.3 \times 10^9$                                       | pH 9 <sup>a,b</sup>       |
| pyrimidine  | $1.0 \times 10^8$                                       | pH 9 <sup>a,b</sup>       |
| purine  | $3.0 \times 10^8$                                       | pH 7 <sup>a,b</sup>       |
| adenine   | $4.6 \times 10^9$                                       | from ref 46 <sup>c</sup>  |
| 9-methyladenine                                   | $4.1 \times 10^9$                                       | from ref 46 <sup>c</sup>  |
| adenosine   | $2.7 \times 10^9$                                       | from ref 46 <sup>c</sup>  |
| 2'-deoxyadenosine                                 | $3.2 \times 10^9$                                       | pH 6 <sup>a,c</sup>       |
| 2'-deoxyadenosineH <sup>+</sup>                   | $4.4 \times 10^9$                                       | pH 2.4 <sup>a,c</sup>     |
| N <sup>6</sup> -methyladenosine                   | $4.9 \times 10^9$                                       | pH 7, <sup>c</sup> ref 52 |
| N <sup>6</sup> ,N <sup>6</sup> -dimethyladenosine | $3.9 \times 10^9$                                       | from ref 46 <sup>c</sup>  |
| guanosine   | $4.1 \times 10^9$                                       | pH 7 <sup>a,c</sup>       |
| guanosineH <sup>+</sup>                           | $3.2 \times 10^9$                                       | pH 0 <sup>a,c</sup>       |
| 2'-deoxyguanosine                                 | $4.1 \times 10^9$                                       | pH 7 <sup>a,c</sup>       |
| poly(A)   | $\leq 10^8$   | b, e                      |
| DNA   | $\leq 10^8$   | b, e                      |
| 2'-deoxyribose                                    | $7.3 \times 10^7$                                       | pH 4.1 <sup>a,b</sup>     |
| ribose 5'-phosphate                               | $2.5 \times 10^7$                                       | pH 4.6 <sup>a,b</sup>     |

<sup>a</sup> Unpublished results. Determined by 248-nm laser photolysis of 20–100 mM  $\text{S}_2\text{O}_8^{2-}$  in the presence of the substrates. <sup>b</sup> Determined by monitoring the decay of  $\text{SO}_4^{\cdot-}$  at 450 nm. <sup>c</sup> Determined by monitoring the buildup of OD at 305–350 nm. <sup>d</sup> Per nucleotide unit. <sup>e</sup> Bothe, E., private communication.

The  $\text{SO}_4^{\cdot-}$  reaction with adenines leads to the one-electron-oxidized and deprotonated species; cf. eq 6:

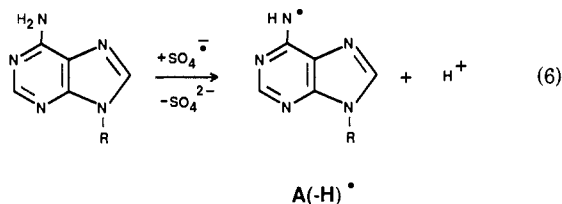

That the radical  $\text{A(-H)}^\cdot$  is deprotonated was shown by conductance;<sup>46</sup> that it is oxidizing (with respect to  $N$ ,  $N'$ ,  $N'$ ,  $N'$ -tetramethyl-*p*-phenylenediamine (TMPD), ascorbate, or phenolic antioxidants<sup>46–49</sup>) was demonstrated by producing it independently, i.e., by addition of OH followed by elimination of  $\text{H}_2\text{O}$ ,<sup>46–48</sup> in the presence of the reductants.<sup>50</sup> The oxidizing nature of the radicals from the reaction with  $\text{SO}_4^{\cdot-}$  was also deduced from the absence of reducing radicals.<sup>13</sup>

The N<sup>6</sup>-centered, anilino type radicals  $\text{A(-H)}^\cdot$  are strong one-electron oxidants in a reaction (eq 7) in which the adenine system is “repaired”<sup>47,48</sup> by the reductant, e.g.

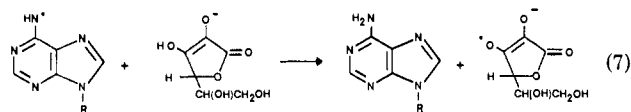

The rate constants for this type of repair have been found to depend on the redox potentials of the reductants.<sup>48</sup> For the powerful one-electron reductant TMPD ( $E_{\text{pH}7}^2 = 0.26 \text{ V/NHE}$ )<sup>51</sup> the rate constant for reaction analogous to eq 7 is  $(2\text{--}5) \times 10^9 \text{ M}^{-1} \text{ s}^{-1}$ ,<sup>46,48</sup> close to the diffusional level.

The reaction between an adenine and  $\text{SO}_4^{\cdot-}$  does not necessarily have to proceed by outer-sphere electron transfer in order to give the one-electron-oxidized adenine. An inner-sphere process<sup>43</sup> (via addition/elimination)<sup>18,19</sup> is also possible. In any case, the primary product of the one-electron oxidation, the radical cation, has a very short lifetime in aqueous solution, and this is due to its high Brønsted acidity as a result of which

the deprotonation reaction of the radical cation is very rapid. Even in the case of N<sup>6</sup>-methyladenosine, a better base than adenosine, the radical cation deprotonates with  $k \geq 1 \times 10^7 \text{ s}^{-1}$  to give the oxidizing N<sup>6</sup>-centered radical:<sup>46,52</sup>

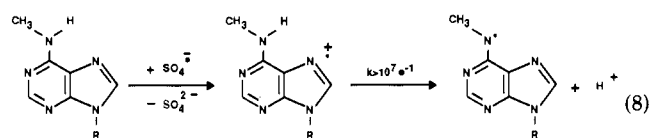

N<sup>6</sup> is not the only deprotonation site of adenine radical cations: if in adenine both hydrogens at N<sup>6</sup> are replaced by methyl, deprotonation takes place at N9;<sup>46,52</sup>

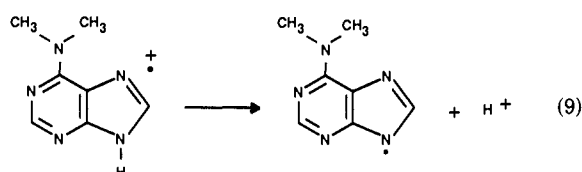

However, if this reaction is made impossible by replacing N9-H by methyl or ribosyl, reaction of  $\text{SO}_4^{\cdot-}$  with the parent compounds N<sup>6</sup>,N<sup>6</sup>,9-trimethyladenine (TMA) or N<sup>6</sup>,N<sup>6</sup>-dimethyladenosine (DMAdo) leads to the corresponding radical cations, which are quite stable and have only a low tendency to react with water by hydration ( $k(\text{hydration}) < 10^3 \text{ s}^{-1}$ ).<sup>53</sup> As are the “N-deprotonated radical cations”, i.e., the N-centered neutral radicals described above, the radical cations of TMA or DMAdo are oxidizing, and this is a basis for their detection as products in other oxidation reactions, such as those induced by OH<sup>53</sup> (see section IV).

Deprotonation from N<sup>6</sup> of the radical cation has also been observed to take place in single crystals, even at 4 K,<sup>30–32</sup> which demonstrates that this reaction has a high intrinsic driving force. This high driving force makes the reaction independent of environmental conditions.

An attempt was made to determine the  $\text{pK}_a$  value of the radical cation of 2'-deoxyadenosine (dAdo) in aqueous solution, 248-nm laser photolysis (20-ns pulses) of 20 mM  $\text{S}_2\text{O}_8^{2-}$  solutions providing  $\text{SO}_4^{\cdot-}$ , which was reacted with 0.2 mM dAdo. The resulting absorption spectra were measured between pH 6, where the neutral, N<sup>6</sup>-deprotonated radical exists,<sup>13,46,52</sup> and pH 0. No change in the spectral shape was seen down to pH 1 and only a small change at pH 0.<sup>54</sup> From this it is concluded that the  $\text{pK}_a$  of the radical cation is  $< 1$ . The rate constant for reaction of  $\text{SO}_4^{\cdot-}$  with protonated dAdo ( $\text{pK}_a = 3.8$ ) was measured at pH 2.4 to be  $4.4 \times 10^9 \text{ M}^{-1} \text{ s}^{-1}$ , even slightly larger than that for reaction with neutral dAdo (see Table II). Compared to the parent compound, dAdo, which has  $\text{pK}_a > 13.75$  for deprotonation from the base moiety,<sup>22</sup>  $\text{pK}_a < 1$  for the radical cation means that the acidity of the adenine system is increased by  $\geq 13$  orders of magnitude on removal of one electron. This translates into a differential driving force for deprotonation of  $\geq 18 \text{ kcal mol}^{-1}$ .

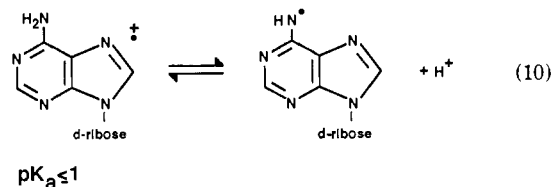

Using a similar approach, the  $pK_a$  value of the radical cation of 2'-deoxycytidine was measured to be  $<4$ ,<sup>54</sup> which means that the acidity of the radical cation is  $>10$  orders of magnitude higher than that of the parent compound.

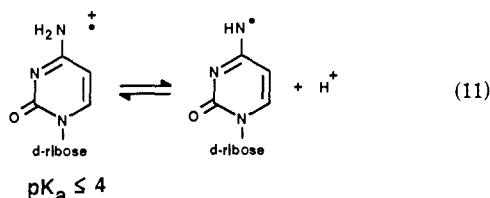

## B. The Guanine System

As is well-known,<sup>1a-d,3c-e</sup> guanine is the most easily oxidized of the nucleic acid bases. MO calculations,<sup>55</sup> ionization potentials,<sup>56</sup> and aqueous-phase redox potentials<sup>44</sup> are in support of a large body of radiation-chemical data that can be interpreted by saying that an electron-loss center created in a system containing the four nucleic acid bases will end up on guanine. The resulting one-electron-oxidized species has frequently been called "the guanine (radical) cation", particularly by ESR spectroscopists, although this is not necessarily intended to mean that the radical carries a positive charge, but rather that some precursor (the "pristine" radical cation) did. This imprecise use of nomenclature (a cation is defined as an entity carrying positive charge) has certainly hampered the communication between ESR spectroscopists and liquid solution radiation chemists, although or because it has been adopted to some extent by the latter.<sup>57</sup>

The guanosine radical cation has been produced in aqueous solution by reaction with OH<sup>-</sup> (for a detailed discussion, see section IV). These authors<sup>58</sup> also found that the oxidant Br<sub>2</sub><sup>-</sup> reacts with 2'-deoxyguanosine 5'-phosphate by one-electron oxidation ( $k = 4 \times 10^7 \text{ M}^{-1} \text{ s}^{-1}$ ). This reaction (and that with 2'-deoxyguanosine) has been studied in detail by O'Neill and Chapman.<sup>59</sup> It was found that the radical formed by reaction with Br<sub>2</sub><sup>-</sup> has itself oxidizing properties. It is able to react at pH 7 with one-electron reductants such as ascorbate, TMPD, phenols, or thiolates (at pH 7–10) and thus behaves much the same as the radical from the reaction of guanosine with OH<sup>-</sup>.<sup>47,58</sup> The dependence on redox potential of the rate constants for oxidation of the reductants by the deoxyguanosine radical at pH 7 follows a Marcus relation,<sup>59</sup> evidence for, but no proof of,<sup>19,60</sup> an outer-sphere electron-transfer mechanism.

The radical produced from deoxyguanosine by reaction with Br<sub>2</sub><sup>-</sup> at pH 7 is *uncharged*, as shown by the absence of a kinetic salt effect in the reaction of the radical with ascorbate.<sup>59</sup> In basic solution, a change in the nature of the radical occurs, evidenced by a decrease of oxidizing power. Starting at pH  $\approx 10$ , the radical loses its ability to oxidize ascorbate, thiol compounds such as cysteine, and phenolates.<sup>59</sup> The dependences of the rate constants for oxidation of the reductants on pH resemble titration curves with inflection points at pH  $\approx 11$ . One reductant that is still quantitatively oxidized even at pH 11 is TMPD.<sup>47</sup> As pointed out by the authors, the reduction in the efficiency of oxidation of thiols and phenols is somewhat surprising since the reductants are more easily oxidized when they are in their (di)anionic forms that prevail at pH  $> 10$ . O'Neill

and Chapman<sup>59</sup> therefore concluded that the decrease in oxidation efficiency with increasing pH was caused by an OH<sup>-</sup>-dependent change in the nature of the oxidizing deoxyguanosine radical. The  $pK_a$  of this radical, produced however by reaction with OH<sup>-</sup>, has been determined to be 10.9,<sup>47</sup> a value very similar to the inflection points (pH 11) of the  $k(\text{oxidation})$  vs pH plots mentioned above.

In order to understand these phenomena more fully, the reaction of Br<sub>2</sub><sup>-</sup> with deoxyguanosine (G) has now been studied over the pH range 3–13.<sup>61</sup> Depending on pH, three distinct forms of the deoxyguanosine-derived radical were identified by their absorption spectra: one form at pH 3, a second existing between pH 4 and 10, and the third at pH  $> 11$ . Plots of OD vs pH yielded sigmoidal curves with inflection points (pK values) at 3.9 and 10.8.<sup>61</sup>

In the pH range 3–12 conductance experiments were carried out to determine the protonation states of the radicals. It was found that the reaction of Br<sub>2</sub><sup>-</sup> with G at pH 5 to  $\sim 6$  leads to the production of one H<sup>+</sup> per Br<sub>2</sub><sup>-</sup> reacting.<sup>61</sup> This means that G loses one H<sup>+</sup> on one-electron oxidation; cf. eq 12. Below pH 4.5 the



Br<sub>2</sub><sup>-</sup>-induced production of H<sup>+</sup> decreased to zero at pH 3. This is explained in terms of protonation of G(-H)<sup>•</sup> to produce the radical cation G<sup>•+</sup>; cf. eq 13. At pH 11.5,

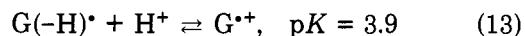

where the deoxyguanosine molecule is present as an anion ( $pK_a(\text{deoxyguanosine}) = 9.4$ ), the Br<sub>2</sub><sup>-</sup>-induced conductance change corresponded to *loss* of OH<sup>-</sup>.<sup>61</sup> This and the information from the optical studies are explained in terms of production of a deoxyguanosine radical anion; cf. eq 14.

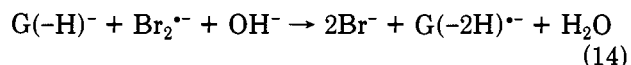

The  $pK_a$  of 10.8, determined by optical and conductance detection, refers to the equilibrium

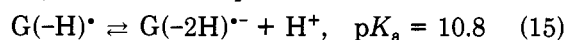

The conclusions concerning the nature of the deoxyguanosine radical and its protonation states, as formed by reaction with Br<sub>2</sub><sup>-</sup>, were checked by using a second oxidant. The radical SO<sub>4</sub><sup>•-</sup> was used for this purpose. In its reaction with aromatics, it is known to lead rapidly to one-electron oxidation products.<sup>19,45</sup> SO<sub>4</sub><sup>•-</sup> was produced by reaction of e<sub>aq</sub><sup>-</sup> with excess S<sub>2</sub>O<sub>8</sub><sup>2-</sup> or by 248-nm photolysis of excess S<sub>2</sub>O<sub>8</sub><sup>2-</sup> (eq 5) in the presence of guanosine or its 2'-deoxy derivative, and the pH was varied between 1 and  $\approx 9$ . Absorption spectra were measured at pH 3 and 7 and found to be identical with those recorded with Br<sub>2</sub><sup>-</sup> as the oxidant.<sup>61</sup> The pK value found was 3.9, the same as that with Br<sub>2</sub><sup>-</sup>. Conductance experiments showed the production of exactly 1 equiv of H<sup>+</sup> per SO<sub>4</sub><sup>•-</sup> reacting with (deoxy)guanosine, if the pH was 5–6 (eq 16), and a decrease of

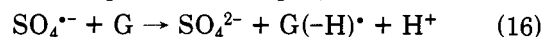

the [H<sup>+</sup>] generated with decreasing pH below pH  $\approx 4.5$  (due to eq 13). These results thus clearly show that the radical produced by one-electron oxidation of (deoxy)guanosine is an *uncharged* species in the pH range 4.5–9.5, in perfect agreement with the finding of O'Neill and Chapman.<sup>59</sup>

## SCHEME II

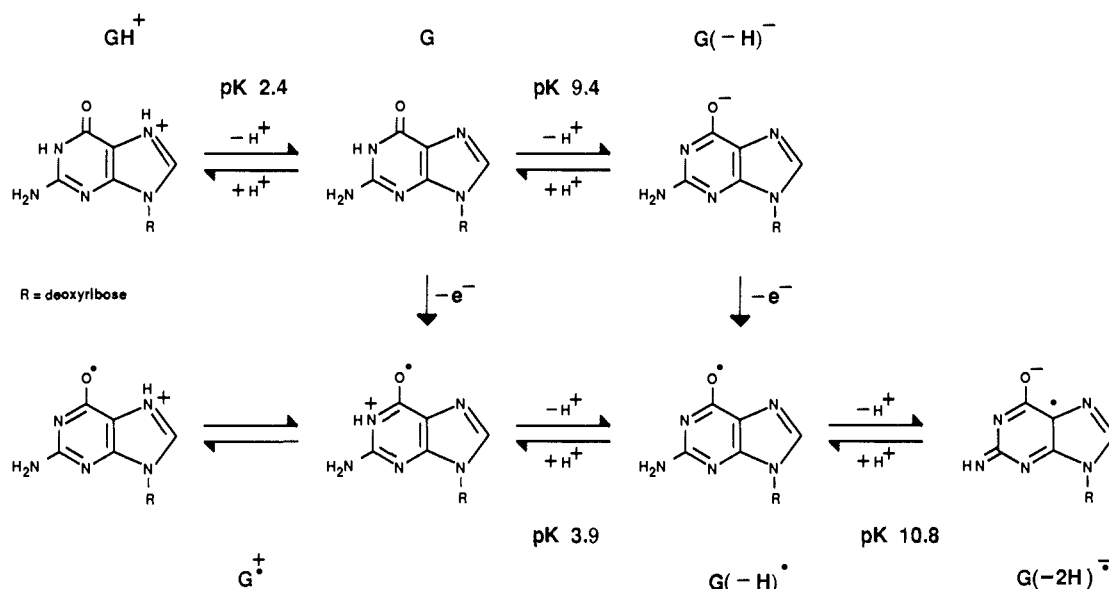

The neutral radical ( $G(-H)^{\bullet}$ ) deprotonates with a  $pK_a$  of 10.8 to become a radical anion ( $G(-2H)^{\bullet-}$ ) that is a considerably weaker oxidant than the neutral radical (in contrast to  $G(-H)^{\bullet}$ , it is not able to oxidize phenols or thiols,<sup>59</sup> vide supra). Interesting is that the radical  $G(-H)^{\bullet}$  is also able to function as a Brønsted base: in acid solution it is protonated to give the radical cation  $G^{\bullet+}$  with an inflection point corresponding to  $pK_a(G^{\bullet+}) = 3.9$ . The results are summarized in Scheme II.

The scheme is not only in agreement with the data referred to and presented above, but it is also consistent with additional information from the literature obtained by using the OH radical. O'Neill and Chapman<sup>59</sup> established that the "oxidizing deoxyguanosine radical"<sup>47,58</sup> produced in the reaction with OH is identical with the radical generated on reaction with  $Br_2^{\bullet-}$ . Using conductance detection, Scholes et al.<sup>62</sup> showed that the guanosine radical cation discovered by Willson et al.<sup>58</sup> has a  $pK_a$  of 3.9, i.e., is not a radical cation at neutral pH. This  $pK_a$  is identical with that using the  $Br_2^{\bullet-}$  or  $SO_4^{\bullet-}$  methods described above, which suggests that the radical is the same. The high-pH acid/base equilibrium ( $pK_a = 10.8$ ) has also been observed: O'Neill reports a  $pK_a$  of 10.9 for a radical produced from deoxyguanosine by reaction with OH.<sup>47</sup> This  $pK_a$  can now be assigned to  $G(-H)^{\bullet}$ , yielding  $G(-2H)^{\bullet-}$  (cf. eq 15 and Scheme II).

The deprotonation reaction of the radical cation  $G^{\bullet+}$  to give the neutral radical  $G(-H)^{\bullet}$  (see eq 13 and Scheme II) is in agreement with the results of recent ESR experiments<sup>63,64</sup> on single crystals of deoxyguanosine 5-phosphate. Both groups<sup>63,64</sup> agree that the radical cation deprotonates between 10 and 77 K. However, they disagree as to the site of deprotonation: Rakvin et al.<sup>63</sup> favor N1; Close et al.,<sup>64</sup> using ENDOR, identify the exocyclic  $NH_2$  groups as the proton donor. In aqueous solution, N1 is the preferred site of deprotonation, as shown by a comparison with results from 1-methylguanosine.<sup>61</sup>

Finally, it is noted that 9-methylguanine on reaction with the one-electron oxidant  $Tl(II)$ <sup>65</sup> gives a radical that is neutral in neutral solution.<sup>5a</sup>

The  $pK_a$  of 3.9 for the deoxyguanosine radical cation  $G^{\bullet+}$  is, at first sight, a surprisingly high value. Since

the  $pK$  for protonation of the parent compound deoxyguanosine is 2.4, the value for the radical cation means that, compared to the parent, the neutral radical ( $G(-H)^{\bullet}$ ) is a better Brønsted base by 1.5 orders of magnitude. At the same time, the protonated radical ( $G^{\bullet+}$ ) is a better Brønsted acid than the parent ( $pK_a(G \rightleftharpoons G(-H)^- + H^+) = 9.4$ ), although the increase in acidity on one-electron oxidation corresponds to only 5.5 orders of magnitude difference observed for, e.g., the "classical" phenol/phenol radical cation system<sup>66</sup> or the  $\geq 13$  orders in the adenosine case (see section IIIA). This increase in acidity results from the decrease of electron density of the  $\pi$ -system due to the loss of one electron. It is reciprocal to the increase in Brønsted basicity resulting from electron addition to a  $\pi$ -system (see example of  $A^{\bullet-}$  discussed in section IIB).

The comparatively too small enhancement in Brønsted acidity observed on electron removal from the guanine system can be understood as resulting from an extensive reorganization of the electronic configuration in the pyrimidine part of the purine moiety leading to more aromaticity, as shown in Scheme II and eq 17:

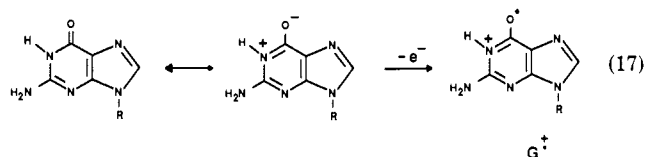

This is equivalent to saying that in the parent compound the zwitterionic resonance form contributes only to a small extent to the overall electron distribution, whereas in the radical the corresponding aromatic form is the dominant one. Obviously, the unpaired spin can reside not only on the exocyclic  $O^6$  but also on  $N^2$  and the endocyclic nitrogens and carbons, as shown by the spin densities for these positions.<sup>63,64</sup>

#### IV. Reactions of the OH Radical

The rate constants for reaction of OH with the electron-rich imidazole are higher compared to those with the electron-deficient pyrimidine (see Table III), a reflection of the electrophilic nature of the OH radical.



**TABLE III. Rate Constants for Reaction of OH at pH ~7 with Purine Components and Derivatives**

| substrate              | $k(\text{OH})^a/$<br>( $\text{M}^{-1} \text{s}^{-1}$ ) | ref |
|------------------------|--|-----|
| imidazole              | $1.2 \times 10^{10}$                                   | 119 |
| pyrimidine             | $1.6 \times 10^8$                                      | 119 |
| purine                 | $3.0 \times 10^8$                                      | 119 |
| adenine                | $6.1 \times 10^9$                                      | 119 |
| adenosine              | $5.8 \times 10^9$                                      | 119 |
| adenosine 5'-phosphate | $4.1 \times 10^9$                                      | 119 |
| guanine                | $9.2 \times 10^9$ <sup>b</sup>                         | 119 |
| guanosine              | $7.8 \times 10^9$                                      | 119 |
| guanosine 5'-phosphate | $4.7 \times 10^9$                                      | 119 |
| hypoxanthine           | $6.5 \times 10^9$                                      | 119 |
| inosine                | $4.8 \times 10^9$                                      | 46  |
| inosine 5'-phosphate   | $2.6 \times 10^9$                                      | 119 |
| xanthine               | $5.2 \times 10^9$                                      | 119 |
| caffeine               | $6.9 \times 10^9$                                      | 119 |
| poly(A)                | $9 \times 10^8$ <sup>c</sup>                           | 85  |
| poly(A+U)              | $5 \times 10^8$ <sup>c</sup>                           | 85  |
| DNA                    | $4 \times 10^8$ <sup>c</sup>                           | 85  |
| ribose 5'-phosphate    | $1.3 \times 10^9$                                      | 119 |

<sup>a</sup> At room temperature. The pH is such that the rates refer to reaction with the nonionized base. <sup>b</sup> Refers to reaction with the guanine anion (pH 10). <sup>c</sup> Rate constant per nucleotide unit.

The reactivity of purine is in between those of its components. Similarly, the lower values for reaction with the nucleosides and nucleotides compared with the free bases probably reflect the decreased electron density due to the electron-withdrawing (-I effect) ribose substituent at N9. The influence of substitution of the purine system at C6 will be discussed in section IVB.

### A. The Guanine System

This system has been thoroughly studied by O'Neill and co-workers.<sup>47,49,59,67</sup> They found that the reaction of OH with 2'-deoxyguanosine (G) and its 5'-monophosphate gives rise to an oxidizing type radical (50%) and to reducing radicals (50%), as determined by redox titration using a variety of reductants (such as, e.g., TMPD, ascorbate, or thiols) and tetranitromethane (TNM) as the oxidant. The oxidizing radical was later<sup>59</sup> recognized to be identical with that produced on reaction with  $\text{Br}_2^{\cdot-}$ , and, as shown in section IIIB, it is identified as the neutral radical  $\text{G}(-\text{H})^{\cdot}$ . The oxidizing nature of this radical is in agreement with the fact<sup>59</sup> that it does not react with  $\text{O}_2$  on the millisecond or shorter time scale. As already mentioned,  $\text{G}(-\text{H})^{\cdot}$  oxidizes ionized thiols such as glutathione or cysteine, the rate constants being  $10^8$ – $10^9 \text{ M}^{-1} \text{ s}^{-1}$ . In contrast, the deprotonated radical (the radical anion  $\text{G}(-2\text{H})^{\cdot-}$ ) is a much weaker oxidant: only the strong reductant TMPD is oxidized by it, but not thiolates, ascorbate, or phenolates.<sup>68</sup>

O'Neill originally interpreted the oxidizing properties of the radical in terms of the OH adduct formed by OH addition to C4 of the guanine system,<sup>47</sup> arguing that appreciable unpaired spin density would be located on O4 (cf. mesomeric structure II).

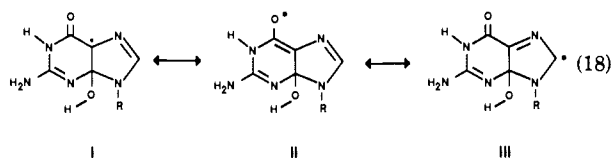

However, with this molecule the resonance form III is equally possible, and if its contribution was large, the

radical would have to be assumed to be *reducing* since the carbon carrying the unpaired electron is substituted by an electron-donating amino group.

Structures I–III demonstrate a phenomenon which is typical for purine radicals, particularly for purine OH adducts, and which may be called "redox ambivalence". The term means that there are mesomeric structures suggestive of easy oxidizability and other, equally likely ones that reflect the opposite, i.e., facile reducibility. If this is indeed so, assignments of radical structure on the basis of redox titration data are not unambiguous. Another example for this is the OH adduct to the 8-position of guanosine:

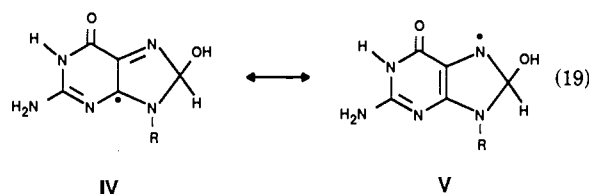

Here it is not a priori clear whether the (reducing) resonance form IV or the (oxidizing) structure V is more important.

In principle, redox ambivalence is a general property of radicals since they are in between two stable oxidation states, which means they can be oxidized or reduced, depending on their reaction partner. In the hypothetical case that oxidant and reductant are strong enough, both types of conversion will be quantitative, and the redox titration technique will then give a total yield of 200%, as shown in eq 20. One of the conse-

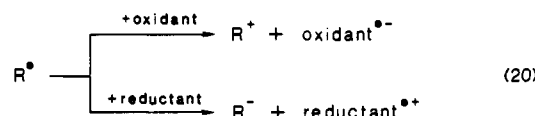

quences of this type of behavior is that an experimental mass balance of 100%, obtained as the sum of reduced oxidant and oxidized reductant, does not necessarily mean that one has accounted for all the radicals formed, since the 100% value may be caused by a redox-ambivalent radical whose yield is just 50%, the remaining 50% being due to (a) redox-inert radical(s).

These considerations serve to demonstrate the difficulties in interpreting experimentally observed yields of reduced oxidants or of oxidized reductants in terms of structure of the reactive radical(s). However, if used with caution and in conjunction with data from other techniques, the information from redox titration can be very valuable.

Concerning the structure of the oxidizing radical from the reaction of OH with the guanine system, the major difficulties related to redox ambivalence vanish if it is assumed that the OH adduct to C4 (structures I–III) eliminates a molecule of water to yield  $\text{G}(-\text{H})^{\cdot}$  (eq 21).

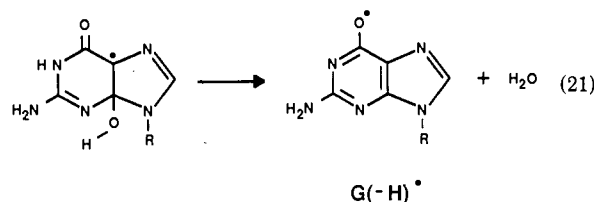

This reaction was in fact considered by O'Neill<sup>47,59</sup> on the basis of the analogous reaction postulated<sup>48</sup> for the

## SCHEME III

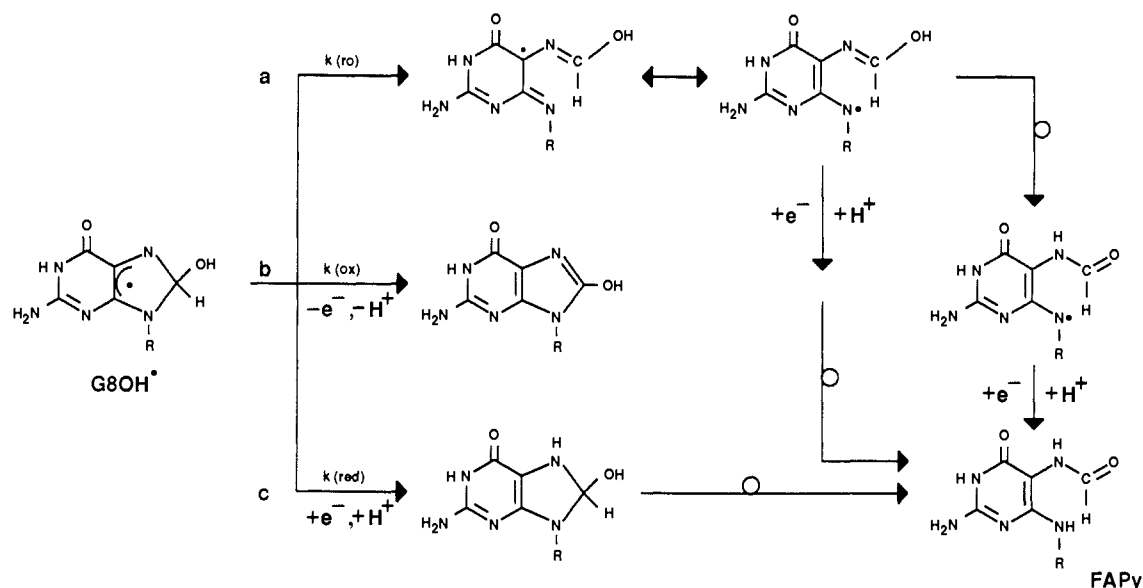

case of deoxyadenosine. The reaction explains why the oxidizing radical from the OH reaction is identical<sup>49,59</sup> with that from the reaction with  $\text{Br}_2^{\cdot-}$  or  $\text{SO}_4^{\cdot-}$  (see section IIIB). In the case of peralkylated systems dehydration of OH adducts consists in elimination of  $\text{OH}^-$  and can therefore be monitored by conductance techniques. This way it was established<sup>53</sup> that the OH adducts to C4 and C5 of  $N^6, N^6$ -dimethyladenosine and  $N^6, N^6, 9$ -trimethyladenine undergo rapid unimolecular dehydration (see section IVB), a reaction analogous to that (eq 21) for the guanine system. Since the product of the dehydration reaction,  $G(-H)^{\cdot+}$ , the one-electron-oxidized guanine system, is a good Brønsted base (see section IIIB), dehydration at acid pH will lead to the guanosine radical cation ( $\text{p}K_a = 3.9$ ).

Concerning the *reducing* radicals produced on reaction of OH with deoxyguanosine, O'Neill suggested the OH adducts to C5 and C8 as possibilities.<sup>47</sup> The C8 OH adduct ( $G8\text{OH}^{\cdot+}$ ) could in fact be predominantly reducing. That it is formed by OH attack is clear from product analysis studies, which, by the way, also attest to the redox ambivalence of the radical. This is shown in Scheme III.

8-Hydroxyguanine derivatives as well as their two-electron-reduced counterparts, 8-hydroxy-7,8-dihydroguanine compounds, have been identified as reaction products.<sup>1a,b,2b,c,5a,69,70</sup> Their formation mechanism (by one-electron oxidation or reduction of the C8 OH adduct) is indicated in Scheme III.  $G8\text{OH}^{\cdot+}$  is also the precursor of the well-known 5-formamido-2,6-diamino type products, abbreviated as FAPy. They are produced by ring opening of  $G8\text{OH}^{\cdot+}$  followed by one-electron reduction of the ring-opened radical with consecutive or concerted protonation. The oxidizing power of the ring-opened radical is expected to be greater when the radical is in the *ketonized* form.

Since the ring opening is unimolecular, it can compete efficiently with the bimolecular oxidation or reduction of  $G8\text{OH}^{\cdot+}$ , unless the concentrations of oxidants or reductants are high. In the case of 9-methylguanine, the OH adduct to C8 has been converted to 8-hydroxy-9-methylguanine by using benzoquinone as a one-electron oxidant, and its yield was measured by HPLC to cor-

respond to 24% of the initially produced OH radicals.<sup>5a</sup> A similar percentage of OH attack at C8 has been observed in the case of adenosine; see section IVB. With 9-methylguanine, 50% of the OH radicals were shown<sup>5a</sup> to yield oxidizing radicals (titrated with the reductants TMPD and promethazine), which were assigned to the OH adduct to C4 or its dehydration product (of type  $G(-H)^{\cdot+}$ ; see eq 21) or to the adduct to C2. The reducing radicals were titrated with *p*-benzoquinone and found to represent 49% of the OH radicals.<sup>5a</sup> Subtracting from this number the 24% due to  $G8\text{OH}^{\cdot+}$  gives 25% for "other" reducing radicals, which were tentatively assigned to the OH adduct to C5. However, the radicals formed by H abstraction from the methyl group at N9 should also be of the reducing type and can therefore be assumed to be included in the residual 25% reducing type category. In the case of deoxyguanosine it has been suggested that 10–20% of the OH radicals react by H abstraction from the sugar.<sup>47</sup>

Concerning OH addition at C5 to give  $G5\text{OH}^{\cdot+}$ , it is certainly reasonable to assume that this radical should be reducing, as suggested by O'Neill,<sup>47</sup> since only little unpaired spin density is expected to be on the nitrogens, as shown in Scheme IV. However,  $G5\text{OH}^{\cdot+}$  may be able to undergo dehydration to yield  $G(-H)^{\cdot+}$ , a reaction that results in redox inversion,<sup>18</sup> which in this case means that the redox character is changed from reducing into oxidizing. Such a dehydration reaction may be taking place on the same time scale as are the scavenging reactions by the redox titrants such as tetranitromethane or *p*-benzoquinone. If this is the case, the experimentally observed ratio of oxidizing to reducing radicals will be dependent on the time elapsed after production of the initial radicals and therefore on the concentrations of oxidant and reductant.

This consideration exemplifies a further potential pitfall of the redox titration technique, as pointed out in eq 22: In it is assumed a unimolecular redox inversion reaction converting a reducing radical  $R(\text{red})^{\cdot+}$  into an oxidizing one  $R(\text{ox})^{\cdot+}$  with the rate constant  $k(\text{inv})$ . Competing with this is a bimolecular reaction (rate constant  $k(\text{red})$ ) by which an oxidant (ox) is reduced by the reducing (primary) radical, or the redox-inverted

## SCHEME IV

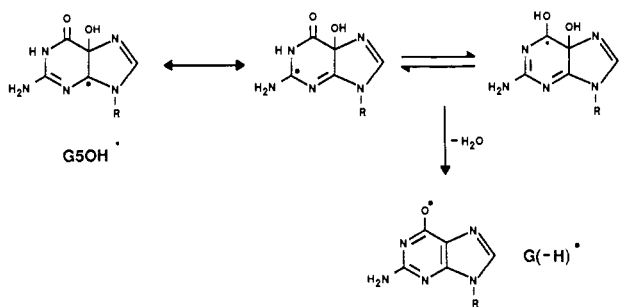

(secondary) radical oxidizes a reductant red (rate constant  $k(\text{ox})$ ):

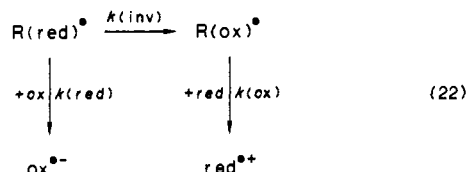

Obviously, the one possible extreme is that  $k(\text{inv})$  is very small as compared to  $k(\text{red})[\text{ox}]$ . This situation leads to the experimental answer that *all* radicals are *reducing*. At the other extreme,  $k(\text{inv})$  is very fast relative to  $k(\text{red})[\text{ox}]$ . The redox titration result would then be that there are *no* reducing radicals, and this result would be confirmed by finding, using an appropriate reductant, that 100% of the radicals are *oxidizing*. In the intermediate case the yields of reducing and oxidizing radicals are dependent on the concentrations of the redox scavengers and the total apparent yield can be >100%.

A simple way to contribute to avoiding wrong conclusions as to the type of radical formed is to always measure the concentrations of reduced oxidant or oxidized reductant *as a function of*  $[\text{ox}]$  and  $[\text{red}]$ . If a plateau value is observed in the  $[\text{ox}^{\bullet-}]$  vs  $[\text{ox}]$  or  $[\text{red}^{\bullet+}]$  vs  $[\text{red}]$  plots, this can be taken as evidence that one has measured something meaningful. In the ideal case, such plateau values are independent of the chemical nature of the oxidant or reductant. However, in practice it turns out to be extremely difficult to fulfill this condition.<sup>71</sup>

In order to summarize the situation with respect to OH reactions with (deoxy)guanosine and their nucleotides, it can be stated that oxidizing and reducing radicals are formed and that the sum of their yields corresponds to  $\geq 100\%$  of the initial OH radicals.<sup>47</sup> A major, if not the only, member of the class of oxidizing radicals is the deprotonated radical cation of type G(-H)<sup>•</sup>, formed by the addition/elimination (=dehydration) sequence of eq 21 and/or Scheme IV. The rate(s) of dehydration are still unknown, but must be  $\geq 10^4 \text{ s}^{-1}$  in order to explain the observation<sup>59</sup> that it is G(-H)<sup>•</sup> which is there on the  $\leq 100\text{-}\mu\text{s}$  time scale. Concerning the reducing radicals, their nature (and possible transformation reactions) will still have to be elucidated in detail. A really satisfactory mass balance, taking into account that, on the basis of product analysis results, addition at C8 can account for at most 25% of the OH radicals, has not yet been achieved.

## B. The Adenine System

The reactivity of the OH radical with 6-substituted

purines increases in a systematic way with increasing electron-donating power of the substituent R(6) at C6.

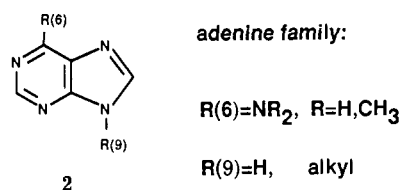

Using  $\sigma^+$  values, the Hammett equation is well obeyed with  $\rho^+ = -0.9$ .<sup>53</sup> The negative  $\rho$  value reflects the electrophilic nature of the OH radical, and it indicates that the transition state for the addition reaction is polar (ion pair type). The  $\rho$  value is more negative than that ( $\rho = -0.5$ )<sup>72</sup> for reaction of OH with substituted benzenes, which also proceeds by addition. The reactivities of the purine 9-ribosides with OH are similar to those of the free bases.

The addition of OH to the 6-substituted purines and purine 9-ribosides leads to at least two different OH adducts: those formed by OH attachment to C4 (denoted A4OH<sup>•</sup>) and those generated by addition to C8 (A8OH<sup>•</sup>); cf. eq 23.

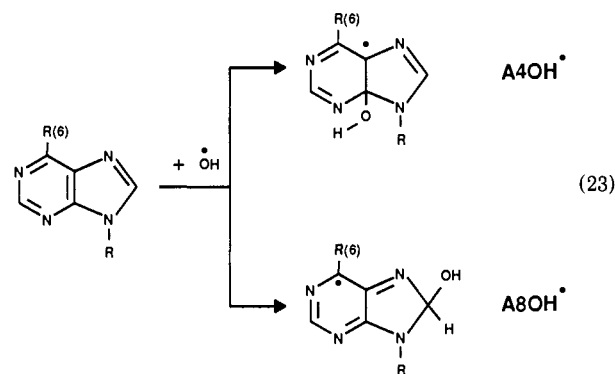

Both A4OH<sup>•</sup> and A8OH<sup>•</sup> undergo unimolecular transformation reactions, which have been assigned to dehydration (of A4OH<sup>•</sup>) and to ring opening (of A8OH<sup>•</sup>).<sup>46,53</sup> In the case of R(6) = NR<sub>2</sub> (the family of "adenines"; R = H, CH<sub>3</sub>) the ring-opening reaction of A8OH<sup>•</sup> always leads to a (first order) *increase* of optical density around 350 nm, whereas the dehydration reaction of A4OH<sup>•</sup> expresses itself by a *decrease* of optical density at  $\sim 410 \text{ nm}$ .<sup>46</sup> The two types of reaction can be distinguished by four criteria: (a) by their different sensitivity to the electronic effect of substituents at C6, (b) by their activation parameters, (c) by their pH dependencies, and (d) by their redox reactivity, particularly with respect to molecular oxygen.<sup>46,52,53</sup>

*The Dehydration Reaction of A4OH<sup>•</sup>.* The dehydration reaction of A4OH<sup>•</sup>, by which a radical that is a very *weak* oxidant<sup>73</sup> (due to the unpaired spin density on N1 and N3) is converted<sup>46,48</sup> into a *strongly* oxidizing radical,<sup>74</sup> leads to neutral N-centered radicals as long as there is at least one hydrogen at N<sup>6</sup> or N<sup>9</sup>:

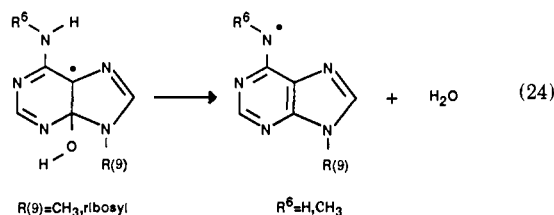

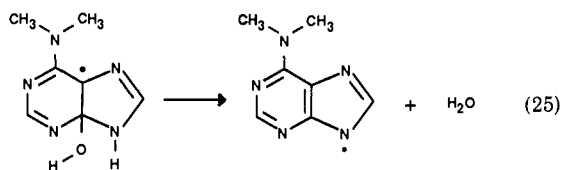

If all exchangeable protons are replaced by alkyl groups as with  $N^6,N^6$ -dimethyladenosine (DMAdo) or  $N^6,N^6,9$ -trimethyladenine (TMA), the dehydration reaction shows up as elimination of  $\text{OH}^-$  and can thereby be detected as such, its rate and yield being measurable by conductance.<sup>53</sup>

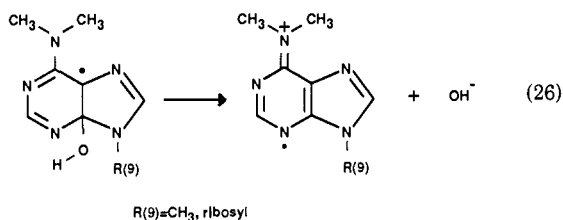

The dehydrated radicals formed in reactions 25 and 26 are oxidizing and can therefore be titrated with reductants such as TMPD.<sup>46,48,53</sup> In the case of DMAdo it was found that the yield of  $\text{TMPD}^{\bullet+}$  measured by this method is the same as that of  $\text{OH}^-$  produced (54% of  $\text{OH}$  at  $\text{pH} \approx 9$ ). This yield can be reduced by introducing  $\text{O}_2$  into the solution. However, the reduction achievable is not quantitative, but corresponds to only 19% of  $\text{OH}$ . The  $\text{O}_2$ -scavengeable radical responsible for this reduction has been assigned in terms of the  $\text{OH}$  adduct to C5, based on its expected reducing properties, which would make it particularly reactive with respect to  $\text{O}_2$ .<sup>53</sup>

In contrast to DMAdo, with adenosine the yield of radical(s) able to oxidize TMPD ( $\approx 30\%$ ; <sup>52</sup> 32% in the case of deoxyadenosine<sup>48</sup>) is *not* decreased in the presence of  $\text{O}_2$ , nor is the rate of formation of  $\text{TMPD}^{\bullet+}$  changed.<sup>52</sup> From this it is concluded that with the adenosine system the probability of  $\text{OH}$  attachment to C5 is  $<10\%$ . In the case of DMAdo the dehydration reaction of  $\text{A4OH}^{\bullet}$  is suppressed by  $\text{OH}^-$ , an example of an  $\text{OH}^-$ -induced inhibition of  $\text{OH}^-$  elimination. This has been explained in terms of a deprotonation equilibrium involving the  $\text{OH}$  group of the hemiorthoamide type radical  $\text{A4OH}^{\bullet}$ , as shown in eq 27:<sup>53</sup>

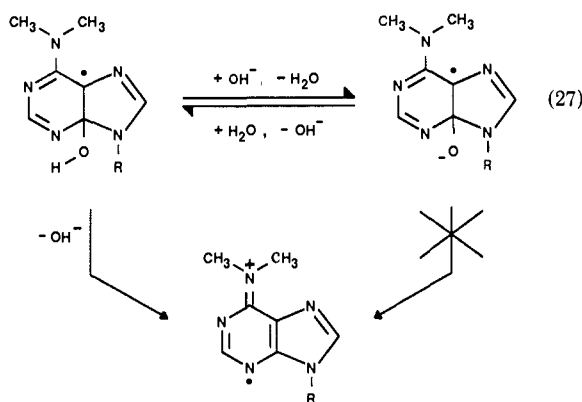

**The Ring-Opening Reaction of  $\text{A8OH}^{\bullet}$ .** This reaction is recognizable by the increase in optical density at  $\approx 350$  nm.<sup>46</sup> It can be quantitatively suppressed by small concentrations of oxidants such as  $\text{O}_2$ <sup>53,75</sup> or Fe-

SCHEME V

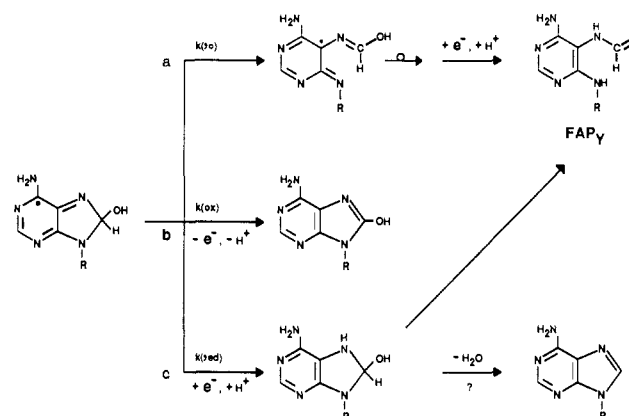

( $\text{CN}$ )<sub>6</sub><sup>3-</sup>,<sup>52,53</sup> which indicates that the radical responsible is strongly reducing. In the case of adenine and adenosine it can be shown by product analysis using HPLC with optical and electrochemical detection that these oxidants reduce the yield of 5-formamido-6-aminopyrimidine type product (FAPy) and increase instead the yield of 8-hydroxyadenine or -adenosine.<sup>76,77</sup> In the presence of  $\geq 1$  mM  $\text{Fe}(\text{CN})_6^{3-}$ , FAPy is undetectable and the yield of 8-hydroxyadenine reaches a maximum value corresponding to  $\approx 25\%$  of  $\text{OH}$ .<sup>76,80</sup>

These results are explained in terms of competition between ring opening and oxidation of  $\text{A8OH}^{\bullet}$ ; cf. Scheme V.

In path c of Scheme V it is shown that  $\text{A8OH}^{\bullet}$  can also be *reduced*, which leads to the corresponding hydrate, in which the elements of water have been added across the N7-C8 bond.<sup>79,81</sup> Reaction paths b and c of Scheme V demonstrate the "redox ambivalence" of  $\text{A8OH}^{\bullet}$ , analogous to the behavior of  $\text{G8OH}^{\bullet}$  (see section IVA). Reaction path c of Scheme V requires the presence of reducing equivalents; in their absence (e.g., if their ultimate precursor,  $e_{\text{aq}}^-$ , is scavenged) the hydrate is essentially not observed. The hydrate, being a hemiorthoamide, is sensitive to hydrolysis, yielding the FAPy derivative. If *dehydration* was taking place, this would constitute a repair reaction (see Scheme V, lower right part).

In the case of DMAdo<sup>53</sup> and TMA<sup>52</sup> the ring-opening reaction of  $\text{A8OH}^{\bullet}$  has been shown to be accelerated by  $\text{OH}^-$ . The mechanism, which is equivalent to that involving nonradical hemiacetals, hemiamidals, or hemiorthoamides,<sup>82</sup> involves deprotonation of the  $\text{OH}$  group at C8. This creates sufficient electron density to speed up the heterolysis of the C8-N9 bond:

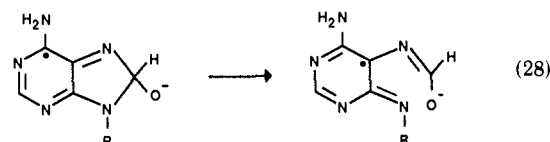

**Substituent Effects on Dehydration and Ring Opening.** The first-order changes in optical density (OD) observed by pulse radiolysis of adenine, (deoxy)adenosine, and its nucleotides in the wavelength regions  $\approx 350$  and  $\approx 410$  nm and assigned to ring opening and dehydration (vide supra) have been known for a long time.<sup>48,75,83-86</sup> In a detailed investigation on adenine van Hemmen found<sup>75</sup> that at room temperature the rate constant for *buildup* of OD at 330 nm is the same as

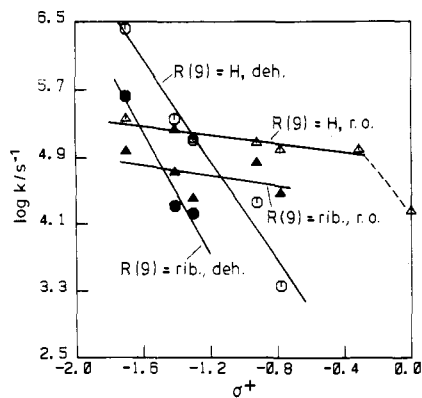
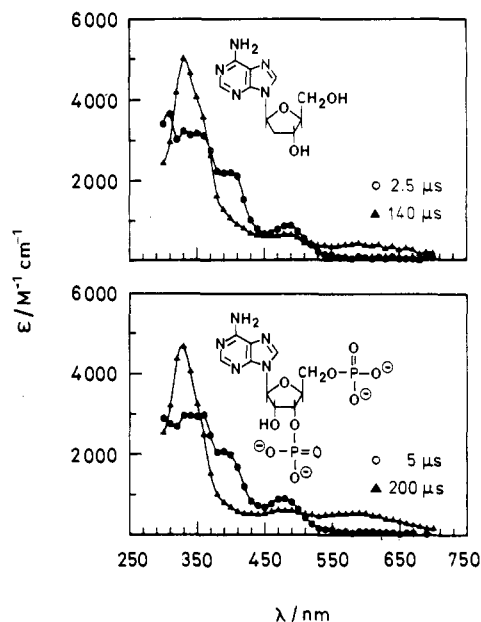

**Figure 3.** Hammett plots for the effect of variation of R(6) on the dehydration (circles) and ring-opening reactions (triangles) at 20 °C: open symbols, R(9) = H; filled symbols, R(9) = ribose. The point for purine has been disregarded in calculating the  $\rho^+$  for the ring-opening reaction for R(9) = H. Reprinted from ref 46; copyright 1987 American Chemical Society.

that ( $1.5 \times 10^5 \text{ s}^{-1}$ ) for the OD decrease at 400 nm. This result was later confirmed, the rates at 20 °C being  $1.3 \times 10^5 \text{ s}^{-1}$ .<sup>46</sup> With the adenine nucleosides and nucleotides the corresponding rates are somewhat smaller. For deoxyadenosine O'Neill found  $(2.9 \pm 0.4) \times 10^4 \text{ s}^{-1}$  for the OD decrease in the region 380–400 nm,<sup>48</sup> and a similar rate was obviously observed for the OD increase in the region <380 nm. In the case of adenosine, the rates at 20 °C are slightly different:  $k = 2.6 \times 10^4 \text{ s}^{-1}$  for the OD buildup at 330 nm and  $1.7 \times 10^4 \text{ s}^{-1}$  for the OD decrease at 400 nm.<sup>46</sup>

The similarity in the room-temperature rates of the two major types of OD change has deceived previous investigators into interpreting the OD changes in terms of only *one* chemical reaction: van Hemmen suggested the ring opening of  $\text{A8OH}^*$ ,<sup>75</sup> having in mind the product analysis results on formation of FAPy and 8-hydroxyadenine derivatives. In contrast, O'Neill<sup>48</sup> interpreted the first-order changes in terms of the dehydration of  $\text{A4OH}^*$  (eq 24) in order to explain the oxidizing properties of the resulting  $\text{N}^6$ -centered radical.

The apparent discrepancy between these hypotheses has been resolved by the observation<sup>46</sup> that *both* ring opening and dehydration are occurring and that the room-temperature rates for the two processes are accidentally identical (with adenine) or very similar (with (deoxy)adenosine and the nucleotides). However, the processes can be distinguished not only by their different pH dependencies<sup>53</sup> (vide supra) but also by their activation parameters,<sup>46,53</sup> particularly with respect to the activation entropy. The most convincing evidence, however, for the reactions underlying the OD changes at  $\approx 350$  and  $\approx 400$  nm being different is the substituent effect on their rates: Figure 3 contains Hammett plots on the effect of the substituent R(6) at C6 on the dehydration (circles) and ring-opening reactions (triangles) at 20 °C. It is obvious that R(6) has a much larger influence on the dehydration reaction ( $\rho^+ = -3.0$ ) than on the ring-opening reaction ( $\rho^+ = -0.3$ ).<sup>46</sup> What is particularly interesting is that the Hammett lines for the dehydration and for the ring-opening reactions intersect at the positions of adenine and of (deoxy)adenosine (R(6) =  $\text{NH}_2$ ). This means that with these compounds, *the room-temperature rates for the two types of reaction are accidentally the same, making it appear as if only one OH adduct isomer is present.*



**Figure 4.** Time-dependent absorption spectra observed on reaction of OH at pH 7 with 0.5 mM 2'-deoxyadenosine and adenosine 3',5'-diphosphate. From ref 87.

The effect of replacing the substituent at N9 is large in going from R(9) = H to R(9) = ribose. As seen by the (parallel) displacement of the Hammett line (see Figure 3), the electron-withdrawing ribose moiety leads to a decrease of the rates of both dehydration and ring opening. In contrast, further variations on the sugar substituent such as going to the 2'-deoxy derivative or introducing one or two phosphate groups at C3' or C5' have only a very small influence on the kind and the rates of the spectral changes, evidence for the base dominating the reaction of OH with the nucleoside or -tide.<sup>87</sup> An example for this is presented in Figure 4.

*Comparison of the Adenine and Guanine Systems.* Finally, a comment may be made on the suggestion<sup>8f</sup> that the guan(os)ine radical cation may undergo hydration (followed by deprotonation of the adduct) or the equivalent reaction with  $\text{OH}^-$  to give an "OH adduct" type radical. On the basis of the results presented on the adenine system, such a reaction is not at all likely to occur in the guan(os)ine case. With adenines, the opposite to hydration, namely *dehydration*, was observed with  $\text{A4OH}^*$  and  $\text{A5OH}^*$ . On the basis of the lower ionization potentials<sup>56</sup> (IP) and the one-electron redox potentials<sup>44</sup>  $E^2$  of guanines compared to adenines, dehydration should be even more favored and hydration even less in the case of the guanines. An example for the relationship<sup>18,19</sup> between propensity for hydration of the radical cation (a function of its electrophilicity) or the reciprocal, the ease of *dehydration* of the OH adduct,<sup>88</sup> and the IP of the parent compound is benzene (IP 9.24 eV) and anisole (IP 8.20 eV): the radical cation of benzene hydrates in aqueous solution completely and irreversibly in  $\leq 20 \text{ ns}$ <sup>18</sup> whereas that of anisole has a lifetime with respect to hydration of  $\geq 10 \text{ ms}$ ,<sup>89</sup> the *dehydration* of the OH adduct being favored in acid solution.

## V. Implications regarding DNA

Results from ESR experiments on oriented DNA fibers by Gräslund et al.,<sup>90</sup> on DNA in frozen aqueous solution,<sup>91</sup> and on dinucleoside phosphates<sup>92,93</sup> have led

to the development of the two-component hypothesis that the electron loss centers (the radical cations, often incompletely denoted as cations) end up with (are trapped by) the purines, particularly with the guanine moiety, whereas the final site of deposition of the ejected electron is with the pyrimidines, particularly with thymine, although the cytosine unit has been offered as an alternative.<sup>21</sup> This and related work has been summarized in enlightening reviews.<sup>3b,d,17b,94-96</sup> The nature of the sites of ultimate deposition of positive and negative charge and unpaired spin is obviously of great importance in understanding the mechanism of radiation-induced damage to DNA, particularly since the demonstration<sup>97,98</sup> that base radicals can induce strand breaks.

The thymine radical anion ( $T^{\bullet-}$ )/guanine radical cation ( $G^{\bullet+}$ ) hypothesis<sup>99</sup> implies that in DNA there are mechanisms of electron and positive hole transfer by which the initially formed and randomly distributed electron gain and loss centers are funneled into the T and G "traps", respectively. It has been pointed out that efficient interbase electron transfer requires overlap of the  $\pi$ -systems of the donor and acceptor bases,<sup>100</sup> a condition fulfilled in DNA by the "base stacking" along the helical axis, with an interbase distance of 0.34 nm.<sup>101</sup>

The  $T^{\bullet-}/G^{\bullet+}$  dichotomy has been criticized by Bernhard<sup>3c,30,102</sup> and recently also by Close et al.<sup>3e</sup> One point of criticism refers to the values of the coupling constants used<sup>90</sup> for the methyl protons to simulate the  $T^{\bullet-}$  spectrum in DNA. The isotropic value for the splitting of the thymine methyl group has recently been determined<sup>16</sup> and this number (0.9 G) is *not* in agreement with that (4.2 G) used in the simulations.

An argument relevant to the *reactivity* of base radicals in aqueous phase refers to the tendency of anionic and cationic base radicals to undergo protonation or deprotonation, even at 4 K. As pointed out in particular by Bernhard,<sup>3c</sup> (de)protonation processes may have drastic effects on chemical reactivity of the species involved. Concerning DNA, with this molecule the stage is set just perfectly for proton transfer to occur, allowing the system to adjust to the change of proton affinity due to ionization (electron loss) or electron pickup. This is simply the result of the fact that in DNA bases occur as *pairs* characterized by preset channels of proton transfer. It follows that, due to the pairwise existence of the bases, it is necessary to treat the chemistry of the ionic base radicals as members of the pair; i.e., the behavior of the partner has to be considered as well.

An example for this is given in Scheme VI, which depicts what probably happens after an electron is removed from a guanine moiety. Deoxyguanosine is a weak acid with a  $pK_a$  of 9.4. The radical cation, however, is a much stronger acid ( $pK_a = 3.9$ ; see section IIIB). The equilibrium positions of one or all of the three protons involved in the hydrogen bonds with the cytosine moiety will therefore be shifted toward the cytosine with the result of an overall transfer of positive charge to that base. Since the  $pK$  value for protonation of deoxycytidine (4.3) is similar to that for *deprotonation* of the guanosine radical cation, it is likely that the guanosine proton will not be transferred fully to the cytidine. Charge transfer in the opposite direction occurs if ionization takes place at the cytosine end of

SCHEME VI. Charge Transfer by Proton Shifts

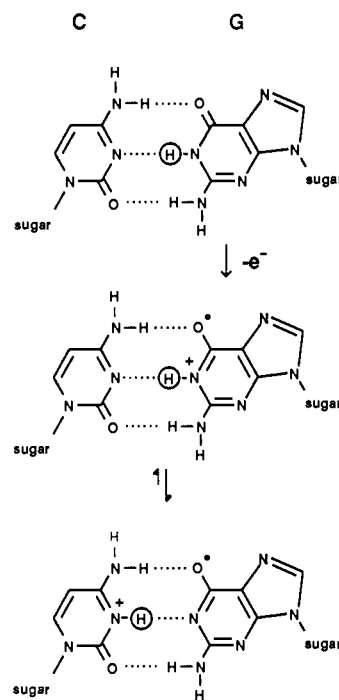

SCHEME VII

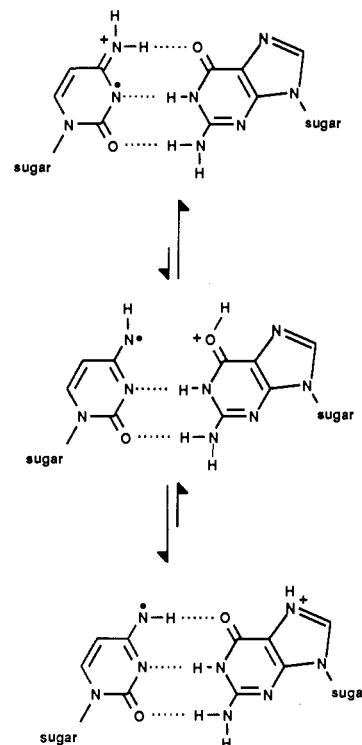

the GC base pair (Scheme VII). In this case the ionization-induced driving force ( $\Delta G$ ) for deprotonation is considerably larger, the  $\Delta pK_a$  (deoxycytidine $^{\bullet+}$ /deoxycytidine)  $\leq -10$  corresponding to  $\Delta G(298\text{ K}) \leq -14\text{ kcal mol}^{-1}$ .<sup>103</sup>

With the adenine/thymine pair the situation is, in principle, analogous (Scheme VIII). Thymine is a very weak Brønsted base ( $pK$  for protonation = -5),<sup>104</sup> so it will not be protonated fully by the radical cation of adenine although this species is a strong Brønsted acid ( $pK_a \leq 1$ ; see section IIIA). Deprotonation of the radical cation of adenine is seen to take place in the solid

## SCHEME VIII

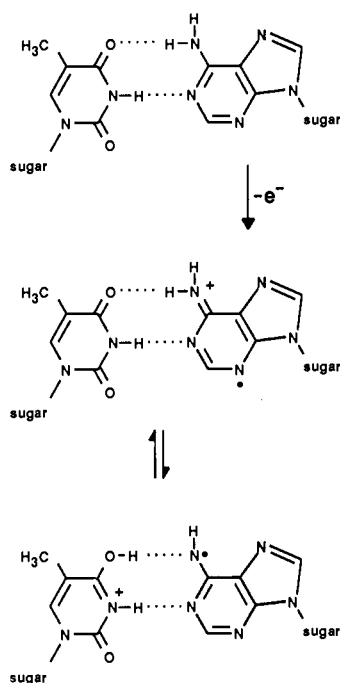

state even at 4 K,<sup>3e,30</sup> evidence for its high intrinsic driving force.

When the thymine moiety is ionized, deprotonation is possible from N3<sup>105</sup> and from the methyl group at C5, but also *hydration* at C5/C6.<sup>13,105-110</sup> Hydration is not only an *irreversible* reaction (as is deprotonation from C5), but it can also lead to an inversion of the redox properties of the system: whereas the radical cation is necessarily an oxidizing species, the water addition radical to C5 of the thymine moiety (the 5-hydroxy-5,6-dihydrothymine-6-yl radical) is reducing.<sup>8</sup> However, if water addition was taking place at C6 (as on reaction of thymine derivatives with SO<sub>4</sub><sup>•-</sup>; see ref 13, 105, 106, and 110), the oxidizing<sup>8</sup> 6-hydroxy-5,6-dihydrothymine-5-yl radical would be the product.

As compared to the radical cations, proton-transfer reactions are at least of the same importance in the case of the radical *anions*. Proton transfer can ultimately lead to protonation on *carbon*, a reaction that is *irreversible* and that results in an inversion of redox character, the C-protonated radicals having lost the reducing character of their N-protonated precursors. This is exemplified with the AT pair and assuming that the electron has been scavenged by A to give A<sup>•-</sup>. As pointed out in section IIIA, electron addition to adenosine leads to an increase in its proton affinity by the factor >10<sup>8</sup>, due to a change in p*K* for protonation from 3.5 for the parent to 12.1 for the radical anion. Since the p*K*<sub>a</sub> for *deprotonation* of thymidine is 9.9, it is likely that A<sup>•-</sup> will be able to pull the N3 hydrogen of T over to its N1, as depicted in Scheme IX.

A slight displacement of the hydrogen from N1 to C2 suffices in order to yield the C2-protonated radical AC2H<sup>•</sup> (Scheme X). In order to obtain the C8-protonated electron adduct (Scheme XI), a protonating agent such as H<sub>2</sub>O is required which, however, has to move in from the periphery of the DNA double helix, possibly from the minor groove.

In contrast to A<sup>•-</sup>, the thymine anion T<sup>•-</sup> is a relatively weak base, the p*K*<sub>a</sub> of the O4-protonated base radical being ~7.<sup>111</sup> This means that the negative

## SCHEME IX

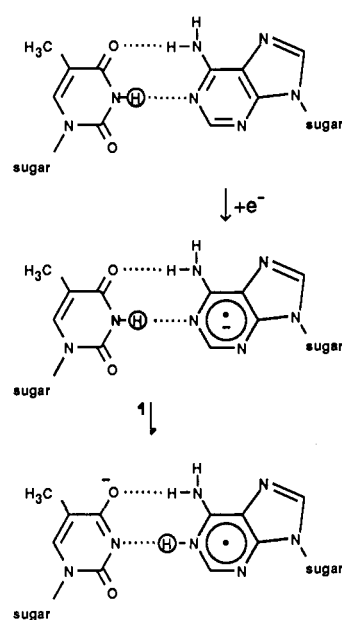

## SCHEME X

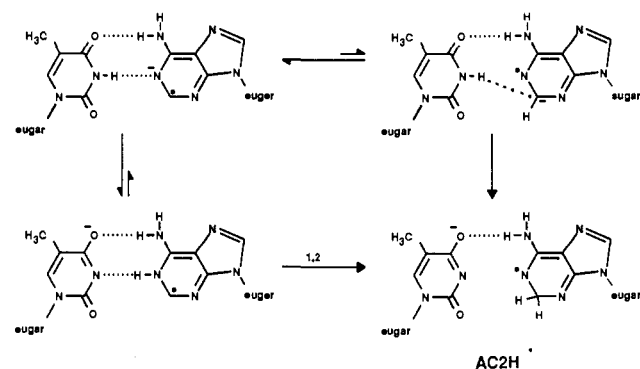

## SCHEME XI

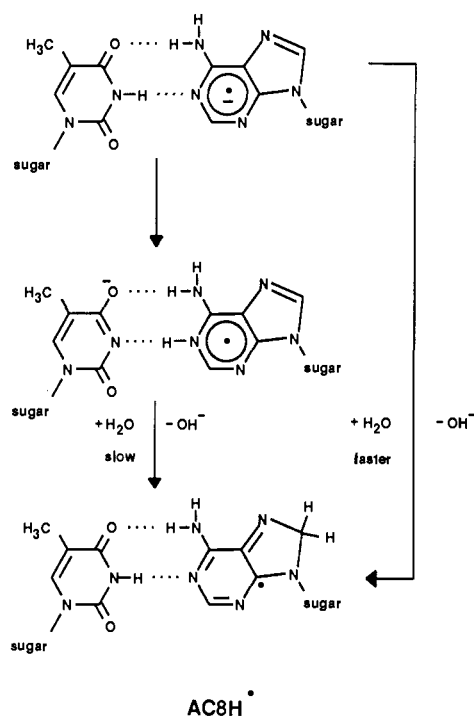

## SCHEME XII

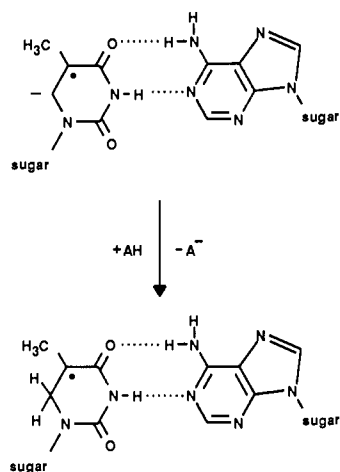

charge on  $T^{\bullet-}$  will not be neutralized much by proton transfer from  $N^6$  of its adenine partner, and this gives external protonating agents such as  $H_2O$  a good chance to protonate  $T^{\bullet-}$  at C6, its unprotected side, yielding the famous 5,6-dihydrothymine-5-yl radical. A sufficient number of  $H_2O$  molecules (6 per base pair), located mainly in the minor groove of DNA,<sup>113</sup> are available for this purpose ( $AH =$  proton donor) (see Scheme XII).

It is relevant at this point to mention that as compared to adenosine $^{\bullet-}$ , whose rate of protonation on carbon is  $3.6 \times 10^6 \text{ s}^{-1}$  in aqueous solution,<sup>24</sup> the corresponding rate for thymidine $^{\bullet-}$  is much smaller, i.e.,  $\leq 10^3 \text{ s}^{-1}$ ,<sup>16,76</sup> in agreement with results<sup>15</sup> from model compounds.<sup>114</sup> Even the (neutral) N-protonated electron adduct of adenosine is protonated on carbon much faster ( $k = 1.4 \times 10^4 \text{ s}^{-1}$ ; see section IIA) than is the radical anion of thymidine. From this point of view, the C-protonated electron adduct of the adenine moiety should have a higher probability of production than that of thymine. It is not clear why this radical has so far not been identified in DNA.

In case the electron is scavenged by C in the G-C pair, it is likely that  $C^{\bullet-}$  will pick up a proton from G, a reaction driven by the enormous increase in basicity in going from the neutral base C ( $pK_a(C(N)H^+) = 4.3$ ) to the radical anion ( $pK_a(C(N)H^{\bullet-}) \geq 13$ )<sup>112</sup> and supported by the acidity of G ( $pK_a(dGuo) = 9.4$ ). In contrast to  $ANH^{\bullet}$  (see section IIB),  $C(N)H^{\bullet}$  has a low tendency to undergo protonation on carbon ( $k(C(N)H^{\bullet} \rightarrow C(C)H^{\bullet}) < 10^3 \text{ s}^{-1}$  at pH 13).<sup>112</sup>

**Electron Transfer vs Proton Transfer.** The puzzle caused by the apparent absence<sup>3</sup> in irradiated DNA of an equal distribution of C, G, A, and T radicals can hypothetically be resolved by assuming that electron transfer from base to base along the helix axis is much faster than proton transfer, which occurs in the direction perpendicular to the helix axis (see Scheme XIII). However, proton transfer along the interbase hydrogen bonds involves only a slight displacement of the equilibrium position of the bridging proton and is therefore likely<sup>115</sup> to also be an extremely fast process (estimated reaction period  $\leq 1 \text{ ps}$ ) against which electron transfer has to compete. Rates of electron transfer in DNA have been estimated by quantum chemical methods to be of the order  $10^{14} \text{ s}^{-1}$ .<sup>116</sup>

Proton transfer leads to separation of charge from spin and it thus converts radical cations (positive holes)

## SCHEME XIII

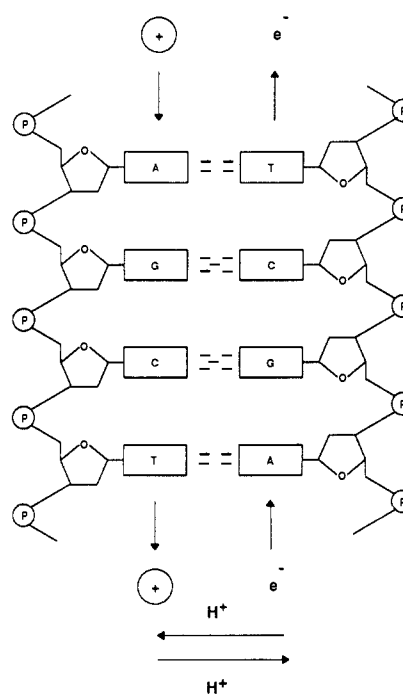

or radical anions (localized but mobile electrons) into neutral radicals. This means that proton transfer destroys or at least slows down the mobility of the charge and spin carriers, which are thereby "frozen" or trapped. Proton-transfer inhibition of electron transfer may be the reason why the migration distance of charge carriers in dry DNA corresponds to less than 25 nucleotide units,<sup>117</sup> although from the point of view of the nearly perfect  $\pi$ -system overlap of the staggered bases much larger distances are expected.<sup>116</sup>

It is interesting that of the two types of proton transfer, the reversible (which occurs between heteroatoms) and the irreversible (which leads to proton attachment to carbon), the latter results in redox inversion. A further aspect is that the irreversible type is more likely to occur in the presence of "external" protonating agents such as water, and this may be related to why the types and the reactivities of radicals observed in DNA depend on its water content,<sup>96,118</sup> evidence for the importance of the hydrogen-bonding network in determining radical behavior.<sup>3c</sup>

**Acknowledgments.** I thank Dietrich Schulte-Frohlinde for arousing my interest in this exciting field, my (former) co-workers and colleagues S. Fujita, D. K. Hazra, H. M. Novais, and A. J. S. C. Vieira for their enthusiasm, motivation, and hard work invested in this area, and L. P. Candeias for the same plus his generous permission to quote unpublished material from his excellent Ph.D. work. I also thank R. Trinoga and M. Stapper for their technical assistance in preparing the manuscript.

## VI. References and Notes

- (1) For reviews, see: (a) Scholes, G. In *Photochemistry and Photobiology of Nucleic Acids*; Wang, S. Y., Ed.; Academic: New York, 1976; Vol. 1, p 521. (b) Scholes, G. In *Effects of Ionizing Radiation on DNA*; Bertinchamps, A. J., Hüttermann, J., Köhnlein, W., Teoule, R., Eds.; Springer: Berlin, 1978; p 153. (c) Bertinchamps, A. J.; Hüttermann, J.; Köhnlein, W.; Teoule, R., Eds. *Effects of Ionizing Radiation on DNA*; Springer: Berlin, 1978. (d) von Sonntag, C. *The*



- Chemical Basis of Radiation Biology*; Taylor and Francis: London, 1987.
- (2) For reviews, see: (a) von Sonntag, C. *Int. J. Radiat. Biol.* 1984, 46, 507. (b) Cadet, J.; Berger, M. *Int. J. Radiat. Biol.* 1985, 47, 127. (c) Cadet, J.; Berger, M.; Shaw, A. *Mechanisms of DNA Damage and Repair*; Simic, M. G., Grossman, L., Upton, A. D., Eds.; Plenum: New York, 1986; p 69. (d) von Sonntag, C.; Schuchmann, H.-P. *Int. J. Radiat. Biol.* 1986, 49, 1.
- (3) For reviews, see: (a) Box, H. C. *Radiation Effects, ESR and ENDOR Analysis*; Academic: New York, 1977. (b) Sevilla, M. D. In *Excited States in Organic Chemistry and Biology*; Pullman, B., Goldblum, N., Eds.; Reidel: Dordrecht, 1977; p 15. (c) Bernhard, W. A. *Adv. Radiat. Biol.* 1981, 9, 199. (d) Hüttermann, J. *Ultramicroscopy* 1982, 10, 25. (e) Close, D. M.; Nelson, W. H.; Sagstuen, E. In *Electronic Magnetic Resonance of the Solid State*; Weil, J. A., Ed.; Can. Soc. Chem.: Ottawa, 1987; p 237. (f) Symons, M. C. R. *J. Chem. Soc., Faraday Trans. 1* 1987, 83, 1.
- (4) For reviews, see: (a) Neta, P. *Adv. Phys. Org. Chem.* 1976, 12, 223. (b) Swallow, A. J. *Prog. React. Kinet.* 1978, 9, 195. (c) Myers, L. S. In *Free Radicals in Biology*; Pryor, W. A., Ed.; Academic: New York, 1980; Vol. 4, p 95. (d) Greenstock, C. L. *Isr. J. Chem.* 1984, 24, 1. (e) von Sonntag, C. *Radiat. Phys. Chem.* 1987, 30, 313.
- (5) (a) Simic, M. G.; Jovanovic, S. V. In *Mechanisms of DNA Damage and Repair*; Simic, M. G., Grossman, L., Upton, A. C., Eds.; Plenum: New York, 1986; p 39. (b) Reference 1d.
- (6) (a) von Sonntag, C.; Hagen, U.; Schön-Bopp, A.; Schulte-Frohlinde, D. *Adv. Radiat. Biol.* 1981, 9, 109. (b) Schulte-Frohlinde, D. In *Radioprotectors and Anticarcinogens*; Nygaard, O. F., Simic, M. G., Eds.; Academic: New York, 1983; p 53.
- (7) (a) Adams, G. E.; Willson, R. L. *Trans. Faraday Soc.* 1969, 65, 2981. (b) Asmus, K.-D.; Möckel, H.; Henglein, A. *J. Phys. Chem.* 1973, 77, 1218 and references therein. (c) References 4a,b.
- (8) Fujita, S.; Steenken, S. *J. Am. Chem. Soc.* 1981, 103, 2540.
- (9) Hazra, D. K.; Steenken, S. *J. Am. Chem. Soc.* 1983, 105, 4380.
- (10) Jovanovic, S. V.; Simic, M. G. *J. Am. Chem. Soc.* 1986, 108, 5968.
- (11) Schuchmann, M. N.; Steenken, S.; Wroblewski, J.; von Sonntag, C. *Int. J. Radiat. Biol.* 1984, 46, 225.
- (12) (a) Greenstock, C. L.; Adams, G. E.; Willson, R. L. In *Radiation Protection and Sensitization*; Moroson, H., Quintiliani, M., Eds.; Taylor and Francis: London, 1970; p 65. (b) Hayon, E.; Simic, M. *J. Am. Chem. Soc.* 1973, 95, 1029. (c) Adams, G. E.; Willson, R. L. *J. Chem. Soc., Faraday Trans. 1* 1973, 69, 719.
- (13) O'Neill, P.; Davies, S. E. *Int. J. Radiat. Biol.* 1987, 52, 577.
- (14) Das, S.; Deeble, D. J.; von Sonntag, C. *Z. Naturforsch.* 1985, 40c, 292.
- (15) Deeble, D. J.; Das, S.; von Sonntag, C. *J. Phys. Chem.* 1985, 89, 5784.
- (16) Novais, H. M.; Steenken, S. *J. Am. Chem. Soc.* 1986, 108, 1.
- (17) For reviews, see: (a) Reference 3c,d. (b) Hüttermann, J.; Voit, K. In *Electronic Magnetic Resonance of the Solid State*; Weil, J. A., Ed.; Can. Soc. Chem.: Ottawa, 1987; p 267.
- (18) Steenken, S. *J. Chem. Soc., Faraday Trans. 1* 1987, 83, 113.
- (19) Steenken, S. In *Free Radicals: Chemistry, Pathology and Medicine*; Rice-Evans, C., Dormondy, T., Eds.; Richelieu: London, 1988; Vol. 3, p 51.
- (20) Moorthy, P. N.; Hayon, E. *J. Am. Chem. Soc.* 1975, 97, 3345.
- (21) Sevilla, M. D.; Failor, R.; Clark, C.; Holroyd, R. A.; Pettei, M. *J. Phys. Chem.* 1976, 80, 353.
- (22) Hissung, A.; von Sonntag, C.; Veltwisch, D.; Asmus, K.-D. *Int. J. Radiat. Biol.* 1981, 39, 63.
- (23) Visscher, K. J.; de Haas, M. P.; Loman, H.; Vojnovic, B.; Warman, J. M. *Int. J. Radiat. Biol.* 1987, 52, 745. Visscher, K. J.; Hom, M.; Loman, H.; Spoelder, H. J. W.; Verberne, J. B. *Radiat. Phys. Chem.* 1988, 32, 465.
- (24) Candeias, L. P., unpublished results.
- (25) Based on the data in Figure 2 of ref 22, using  $\epsilon(\text{ACH}^{\bullet+})$  at 355 nm to be  $\geq 13\,000\text{ M}^{-1}\text{ cm}^{-1}$  and  $\epsilon(\text{pNAP}^{\bullet+})$  at 550 nm to be  $2900\text{ M}^{-1}\text{ cm}^{-1}$ .<sup>26</sup> The remaining  $\leq 16\%$  of the  $\text{ANH}^{\bullet+}$  was suggested<sup>22</sup> to react with pNAP by addition.
- (26) Jagannadham, V.; Steenken, S. *J. Am. Chem. Soc.* 1984, 106, 6542.
- (27) Steenken, S.; Davies, M. J.; Gilbert, B. C. *J. Chem. Soc., Perkin Trans. 2* 1986, 1003.
- (28) Hayon, E.; Lichtin, N. N.; Madhavan, V. *J. Am. Chem. Soc.* 1973, 95, 4762; *Radiat. Res.* 1973, 55, 589.
- (29) This is analogous to enol-keto tautomerization (which, however, consists of a 1,3-shift of an H from oxygen to carbon).
- (30) Kar, L.; Bernhard, W. A. *Radiat. Res.* 1983, 93, 232.
- (31) Protonation on carbon of the adenosine electron adduct in aqueous solution has previously been suggested by Sevilla et al.<sup>21</sup>
- (32) Eigen, M. *Angew. Chem.* 1963, 75, 489.
- (33) Albery, W. J. *Annu. Rev. Phys. Chem.* 1980, 31, 227.
- (34) Fessenden, R. W.; Chawla, O. P. *J. Am. Chem. Soc.* 1974, 96, 2262.
- (35) Buick, A. R.; Kemp, T. J.; Neal, G. T.; Stone, T. J. *J. Chem. Soc. A* 1969, 1609.
- (36) Neta, P. *Radiat. Res.* 1972, 52, 471.
- (37) Fessenden, R. W.; Neta, P. *Chem. Phys. Lett.* 1973, 18, 14.
- (38) Zeldes, H.; Livingston, R.; Bernstein, J. S. *J. Magn. Reson.* 1976, 21, 9 and references therein.
- (39) Moorthy, P. N.; Hayon, E. *J. Phys. Chem.* 1974, 78, 2615.
- (40) Rakowsky, T.; Dohrmann, J. K. *Ber. Bunsenges. Phys. Chem.* 1979, 83, 495 and references therein.
- (41) For a recent compilation of  $\text{p}K_{\text{a}}$  values of radicals, see: Dohrmann, J. K. In *Landolt-Börnstein, Zahlenwerte und Funktionen aus Naturwissenschaften und Technik, Gruppe II, Band 13, Teilband e*; Springer: Berlin, 1985; p 5.
- (42) It would be interesting to compare the absorption spectrum of the H adduct of adenosine determined at neutral pH with that of the C-protonated electron adduct.
- (43) Ebersson, L. *Adv. Phys. Org. Chem.* 1982, 18, 79.
- (44) Jovanovic, S. V.; Simic, M. G. *J. Phys. Chem.* 1986, 90, 974.
- (45) Neta, P.; Madhavan, V.; Zemel, H.; Fessenden, R. W. *J. Am. Chem. Soc.* 1977, 99, 163.
- (46) Vieira, A. J. S. C.; Steenken, S. *J. Phys. Chem.* 1987, 91, 4138.
- (47) O'Neill, P. *Radiat. Res.* 1983, 96, 198.
- (48) O'Neill, P.; Chapman, P. W.; Papworth, D. G. In *Free Radicals in Biology and Medicine*; Harwood: Chur, 1985; p 62.
- (49) O'Neill, P.; Davies, S. E. *Int. J. Radiat. Biol.* 1986, 49, 937.
- (50) If the radical cation did not deprotonate but reacted by addition of  $\text{H}_2\text{O}$  to give hydroxycyclohexadienyl type radicals ("OH adducts"), these would likely not be oxidizing but reducing.<sup>18</sup>
- (51) Steenken, S. In *Landolt-Börnstein, Zahlenwerte und Funktionen aus Naturwissenschaften und Technik, Gruppe II, Band 13, Teilband e*; Springer: Berlin, 1985; p 147.
- (52) Vieira, A. J. S. C., unpublished results.
- (53) Vieira, A. J. S. C.; Steenken, S. *J. Am. Chem. Soc.* 1987, 109, 7441.
- (54) Steenken, S., unpublished results.
- (55) Pullman, B.; Pullman, A. *Quantum Biochemistry*; Interscience: New York, 1963.
- (56) Hush, N. S.; Cheung, A. S. *Chem. Phys. Lett.* 1975, 34, 11.
- (57) It is misleading and therefore uneconomical to identify the offspring by the name of the (great)grandparent.
- (58) Willson, R. L.; Wardman, P.; Asmus, K.-D. *Nature* 1974, 252, 323.
- (59) O'Neill, P.; Chapman, P. W. *Int. J. Radiat. Biol.* 1985, 47, 71.
- (60) Jagannadham, V.; Steenken, S. *J. Am. Chem. Soc.* 1988, 110, 2188.
- (61) Candeias, L. P.; Steenken, S. *J. Am. Chem. Soc.* 1989, 111, 1094.
- (62) Asmus, K.-D.; Deeble, D. J.; Garner, A.; Idriss Ali, K. M.; Scholes, G. *Br. J. Cancer, Suppl. III* 1978, 37, 46.
- (63) Rakvin, B.; Herak, J. N.; Voit, K.; Hüttermann, J. *Radiat. Environ. Biophys.* 1987, 26, 1.
- (64) Hole, E. O.; Nelson, W. H.; Close, D. M.; Sagstuen, E. *J. Chem. Phys.* 1987, 86, 5218.
- (65) Asmus, K.-D.; Bonifacic, M.; Toffel, P.; O'Neill, P.; Schulte-Frohlinde, D.; Steenken, S. *J. Chem. Soc., Faraday Trans. 1* 1978, 74, 1820.
- (66) Dixon, W. T.; Murphy, D. J. *Chem. Soc., Faraday Trans. 1* 1976, 72, 1221.
- (67) O'Neill, P. In *Oxidative Damage and Related Enzymes*; Rotilio, G., Bannister, J. V., Eds.; Harwood: Chur, 1984; p 337.
- (68) The negative charge on the latter probably contributes to the slowness of the reaction.
- (69) Berger, M.; Cadet, J. *Z. Naturforsch.* 1985, 40b, 1519.
- (70) Dizdaroglu, M. *Biochemistry* 1985, 24, 4476. Dizdaroglu, M.; Bergtold, D. S. *Anal. Biochem.* 1986, 156, 182.
- (71) This is true not only because of the intrinsic redox ambivalence of radicals but also as a result of changes in the reaction mechanism as the driving force of the redox reaction is changed, e.g., a change from electron transfer to addition; see, e.g., ref 19.
- (72) Neta, P.; Dorfman, L. M. In *Radiation Chemistry*; American Chemical Society: Washington, DC, 1968; Vol. I, p 222.
- (73)  $\text{A4OH}^{\bullet}$  from adenosine 5'-phosphate ( $\text{A5'MP}$ ) oxidizes TMPD with  $k = 2.3 \times 10^7\text{ M}^{-1}\text{ s}^{-1}$ .<sup>46</sup>
- (74) In the case of  $\text{A5'MP}$  the rate constant for oxidation of TMPD is  $5 \times 10^9\text{ M}^{-1}\text{ s}^{-1}$ .<sup>46</sup>
- (75) van Hemmen, J. J. *Int. J. Radiat. Biol.* 1975, 27, 403.
- (76) Steenken, S., unpublished results.
- (77) This is in agreement with earlier work; cf. ref 78 and 79.
- (78) Hems, G. *Nature* 1960, 185, 525; 1960, 186, 710; *Radiat. Res.* 1960, 13, 777.
- (79) van Hemmen, J. J.; Bleichrodt, J. F. *Radiat. Res.* 1971, 46, 444.
- (80) A similar observation has been made by Scholes et al.,<sup>62</sup> who found that in the case of adenine,  $\text{Fe}(\text{CN})_6^{3-}$  increases the yield of OH-induced 8-hydroxyadenine to 20% of OH.
- (81) van Hemmen, J. J. *Nature* 1971, 231, 79.

- (82) For reviews on solvolysis mechanisms involving nonradical acetals, orthoesters, or amides, see, e.g.: McClelland, R. A.; Santry, L. J. *Acc. Chem. Res.* 1983, 16, 394. Capon, B.; Dosunmu, M. I.; Sanchez, M. N. M. *Adv. Phys. Org. Chem.* 1985, 21, 37.
- (83) Scholes, G.; Shaw, P.; Willson, R. L.; Ebert, M. In *Pulse Radiolysis*; Ebert, M., Keene, J. P., Swallow, A. J., Baxendale, J. H., Eds.; Academic: London, 1965; p 151.
- (84) Willson, R. L. *Int. J. Radiat. Biol.* 1970, 17, 349.
- (85) Michaels, H. B.; Hunt, J. W. *Radiat. Res.* 1973, 56, 57.
- (86) Fell, N. S.; Zaozerskaya, L. A. *ZFI-Mitteilungen* 1981, 43b, 273.
- (87) Vieira, A. J. S. C.; Steenken, S., manuscript in preparation.
- (88) Holcman, J.; Sehested, K. *Nukleonika* 1979, 24, 887.
- (89) O'Neill, P.; Steenken, S.; Schulte-Frohlinde, D. *J. Phys. Chem.* 1975, 79, 2773.
- (90) Gräslund, A.; Ehrenberg, A.; Rupprecht, A.; Ström, G. *Biochim. Biophys. Acta* 1971, 254, 172. Gräslund, A.; Ehrenberg, A.; Rupprecht, A.; Ström, G.; Crespi, H. *Int. J. Radiat. Biol.* 1975, 28, 313.
- (91) Gregoli, S.; Olast, M.; Bertinchamps, A. *Radiat. Res.* 1982, 89, 238.
- (92) Sevilla, M. D.; D'Arcy, J. B.; Morehouse, K. M.; Engelhardt, M. L. *Photochem. Photobiol.* 1979, 29, 37.
- (93) Gregoli, S.; Olast, M.; Bertinchamps, A. *Radiat. Res.* 1979, 77, 417.
- (94) Herak, J. N. In *Magnetic Resonance in Chemistry and Biology*; Herak, J. N., Adamic, K. J., Eds.; Marcel Dekker: New York, 1975; p 315.
- (95) Hüttermann, J.; Voit, K.; Oloff, H.; Köhnlein, W.; Gräslund, A.; Rupprecht, A. *Faraday Discuss. Chem. Soc.* 1984, 78, 135.
- (96) Oloff, H.; Riederer, H.; Hüttermann, J. *Ultramicroscopy* 1984, 14, 183.
- (97) Lemaire, D. G. E.; Bothe, E.; Schulte-Frohlinde, D. *Int. J. Radiat. Biol.* 1984, 45, 351. Deeble, D. J.; von Sonntag, C. *Ibid.* 1984, 46, 247.
- (98) Boon, P. J.; Cullis, P. M.; Symons, M. C. R.; Wren, B. W. *J. Chem. Soc., Perkin Trans. 2* 1984, 1393. Cullis, P. M.; Symons, M. C. R. *Radiat. Phys. Chem.* 1986, 27, 93. See also ref 3f.
- (99) This hypothesis has recently been modified in favor of a neutral guanine radical being formed, produced by deprotonation from N-1 of the radical cation precursor (see ref 17b).
- (100) Gregoli, S.; Olast, M.; Bertinchamps, A. *Radiat. Res.* 1977, 70, 255.
- (101) Adams, R. C. P.; Knowler, J. T.; Leader, D. P. *The Biochemistry of the Nucleic Acids*, 10th ed.; Chapman and Hall: London, 1986; p 15. van de Vorst, A.; Westhof, E. In *Effects of Ionizing Radiation on DNA*; Hüttermann, J., Köhnlein, W., Teoule, R., Bertinchamps, A. J., Eds.; Springer: Berlin, 1978; p 3.
- (102) Recent results of Bernhard (*Radiat. Res.*, in press; *J. Phys. Chem.*, submitted) indicate that an  $e^-$  is more likely to be trapped by a cytosine than by a thymine.
- (103) It may be argued that gas-phase proton affinities rather than (aqueous phase)  $pK_a$  values should be used to characterize basicities since the species involved in the proton transfer are not hydrated in DNA. Such data are not known, however, for the base radicals. Data on the parent compounds, the bases, do exist; cf., e.g.: Del Bene, J. E. *J. Phys. Chem.* 1983, 87, 367.
- (104) Garcia, B.; Palacios, J. C. *Ber. Bunsenges. Phys. Chem.* 1988, 92, 696.
- (105) Deeble, D. J.; von Sonntag, C.; Steenken, S., unpublished results.
- (106) Fockenberg, F.; Steenken, S., unpublished results.
- (107) Schulte-Frohlinde, D. In *Mechanisms of DNA Damage and Repair*; Simic, M. G., Grossman, L., Upton, A. C., Eds.; Plenum: New York, 1986; p 19.
- (108) Opitz, J.; Schulte-Frohlinde, D. *J. Photochem.* 1987, 39, 145.
- (109) Schuchmann, H.-P.; Deeble, D. J.; Olbrich, G.; von Sonntag, C. *Int. J. Radiat. Biol.* 1987, 51, 441.
- (110) Behrens, G.; Hildenbrand, K.; Schulte-Frohlinde, D.; Herak, J. N. *J. Chem. Soc., Perkin Trans. 2* 1988, 355.
- (111) As judged from the  $pK_a$  of the protonated electron adduct of thymidine, determined by pulse radiolysis to be 6.9.<sup>112</sup>
- (112) Telo, J. P.; Candeias, L. P.; Steenken, S., unpublished results.
- (113) For a discussion of the dynamics and structure of water bound to DNA, see: Kuwabara, S.; Umehara, T.; Mashino, S.; Yagihara, S. *J. Phys. Chem.* 1988, 92, 4839 and references therein.
- (114) However, in the case of thymidine 5'-phosphate at pH 9.2, the electron adduct has been reported to be protonated (on C-6) with  $k = 5 \times 10^3 \text{ s}^{-1}$  (Spoelder, H. J. W. *Dissertation*, Vrije Universiteit Amsterdam, 1987).
- (115) For a general discussion, see, e.g.: Kosower, E. M.; Huppert, D. *Annu. Rev. Phys. Chem.* 1986, 37, 127 and references therein.
- (116) Dee, D.; Baur, M. E. *J. Chem. Phys.* 1974, 60, 541.
- (117) van Lith, D.; Warman, J. M.; de Haas, M. P.; Hummel, A. *J. Chem. Soc., Faraday Trans. 1* 1986, 82, 2933. van Lith, D.; Eden, J.; Warman, J. M.; Hummel, A. *J. Chem. Soc., Faraday Trans. 1* 1986, 82, 2945.
- (118) See also, e.g.: Strand, P.; Sagstuen, E.; Lehner, T.; Hüttermann, J. *Int. J. Radiat. Biol.* 1987, 51, 303.
- (119) Buxton, G. V.; Greenstock, C. L.; Helman, W. P.; Ross, A. B. *J. Phys. Chem. Ref. Data* 1988, 17, 513.
- (120) Shragge, P. C.; Michaels, H. B.; Hunt, J. W. *Radiat. Res.* 1971, 47, 598.